



# Control Panel

Solution 2000 / 3000



**BOSCH**

**en** Installation Guide



## Table of contents

<b>1</b>	<b>Introduction</b>	<b>8</b>
1.1	About documentation	8
1.2	Bosch Security Systems, Inc. product manufacturing dates	8
<b>2</b>	<b>System Overview</b>	<b>10</b>
2.1	Product Matrix	10
2.2	Configuration and Parts	10
2.2.1	Control panel capacities	10
2.2.2	Parts list	11
2.2.3	Order separately	11
<b>3</b>	<b>Installation workflow</b>	<b>12</b>
<b>4</b>	<b>Accessories</b>	<b>13</b>
4.1	Codepads	13
4.1.1	Installer Menu	15
4.2	WE800EV2 receiver	17
4.3	HCT-4 keyfob	18
4.4	RADION receiver B810	18
4.5	RADION keyfobs	18
4.6	RADION repeater	19
4.7	RADION detectors	19
4.8	B308 Octo-output Module	19
4.9	B426 Conettix Ethernet Communication Modules	20
4.10	B450 Conettix Plug-in Communicator Interfaces	20
4.11	A-Link Plus Software	21
4.12	Remote Security Control	22
4.13	Keyswitches	22
4.14	TF008 Plug Pack (TF008-B)	22
4.14.1	Install the transformer	23
4.15	DLA	23
<b>5</b>	<b>Configuration</b>	<b>24</b>
5.1	Installer Commands	24
5.1.1	Command 958 - Exit from Installer's Programming Mode without saving changes	24
5.1.2	Command 959 - Test IUI-SOL-ADAPTER	24
5.1.3	Command 960 - Save and exit from Installer's Programming Mode	25
5.1.4	Command 961 - Reset the Control Panel to Factory Default Settings	25
5.1.5	Command 962 - Copy the Control Panel Memory to IUI-SOL-ADAPTER	25
5.1.6	Command 963 - Copy IUI-SOL-ADAPTER data to the Control Panel	26
5.1.7	Command 965 - Set up Domestic Dialing Format	26
5.1.8	Command 966 - Enable/Disable the Automatic Stepping of Locations	27
5.1.9	Command 999 - Display the Control Panel Firmware Version Number	27
5.2	Disable Factory Defaults	28
<b>6</b>	<b>System Operations</b>	<b>30</b>
6.1	Arming the system in AWAY Mode	30
6.2	Disarming the system from AWAY Mode	30
6.3	Arming the System in STAY Mode 1	31
6.4	Disarming the system from STAY Mode 1	32
6.5	Arming the system from STAY Mode 2	32
6.6	Disarming the system from STAY Mode 2	33

6.7	Codepad duress alarm	33
6.8	Codepad panic alarm	33
6.9	Codepad fire alarm	34
6.10	Codepad medical alarm	34
6.11	Isolating zones	34
6.11.1	Standard isolating	34
6.11.2	Code to isolate	35
6.12	Fault analysis mode	35
6.13	Fault descriptions	36
<b>7</b>	<b>System Functions</b>	<b>39</b>
7.1	Installer Code Functions	39
7.1.1	Add or Delete RF Wireless Devices	39
7.1.2	Add/Delete RF Repeater	40
7.1.3	Add/Delete RF Keyfob	41
7.1.4	Set the Number of Days until the First Test Report	42
7.1.5	Change Domestic Phone Numbers	42
7.1.6	Change Telco Arm/Disarm Sequence	43
7.1.7	Setting STAY Mode 2 Bypass Zones	45
7.1.8	Turning Report Monitor Mode On and Off	45
7.1.9	Walk Test Mode	46
7.1.10	Event Memory Recall Mode	46
7.2	Master Code Functions	47
7.2.1	Arm or Disarm both Areas at the Same Time	48
7.2.2	Arm or Disarm Single Area	48
7.2.3	Changing and Deleting User Codes	49
7.2.4	Adding Remote Radio User Codes	49
7.2.5	Deleting User/Radio Codes	50
7.2.6	Change Domestic Phone Numbers	50
7.2.7	Change Telco Arm/Disarm Sequence	51
7.2.8	Setting STAY Mode 2 Bypass Zone	51
7.2.9	Turning Outputs On and Off	51
7.2.10	Setting the Date and Time	52
7.2.11	Walk Test Mode	52
7.2.12	Event Memory Recall Mode	52
7.2.13	System reset	52
7.3	User Code Functions	52
7.3.1	Arm or Disarm both Areas at the Same Time	52
7.3.2	Arm or Disarm Single Area	53
7.4	Hold-Down Functions	53
7.4.1	Arm the System in AWAY Mode	53
7.4.2	Arm the System in STAY Mode 1	53
7.4.3	Arm the System in STAY Mode 2	53
7.4.4	Horn Speaker Test	53
7.4.5	Bell Test	54
7.4.6	Strobe Test	54
7.4.7	Turning Day Alarm On and Off	54
7.4.8	Fault Analysis Mode	54
7.4.9	Initiate a Modem Call	54
7.4.10	Reset Latching Outputs	54

7.4.11	Change the Codepad Buzzer Tone	55
7.4.12	Send Test Report	55
<b>8</b>	<b>RF Keyfob Operations</b>	<b>56</b>
8.1	Indications from RF Keyfob Operations	56
8.2	Remote Radio User Code Priority Levels	56
<b>9</b>	<b>Remote Arming by Telephone</b>	<b>57</b>
<b>10</b>	<b>A-Link Plus Application</b>	<b>58</b>
10.1	Modem Connection	58
10.1.1	Remote Connection with Customer Control	58
10.1.2	Remote Connection without Callback Verification	58
10.1.3	Remote Connection with Callback Verification	59
10.1.4	Answering Machine Bypass Connection	59
10.2	Network Connection	59
10.3	Direct Connection	60
10.4	Options	60
10.5	Configuring for email	60
10.5.1	Configure through B426	61
10.5.2	Configure through B450	63
<b>11</b>	<b>Communication Information</b>	<b>65</b>
11.1	Primary Telephone Number for Receiver 1 and Receiver 2	66
11.2	Secondary Telephone Number for Receiver 1 and Receiver 2	66
11.3	Transmission Format for Receiver 1 and Receiver 2	66
11.4	Subscriber ID Number for Receiver 1 and Receiver 2	67
11.5	IP Items for Receiver 1 and Receiver 2	67
11.6	Conettix Items for Receiver 1 and Receiver 2	68
11.7	External Network Modules	69
11.8	Password for A-Link Connection	69
11.9	DTMF Timing Compensation	70
11.10	Country Codes	70
11.11	Telco Arming Sequence	70
11.12	Telco Disarming Sequence	71
11.13	Call Back Telephone Number	71
11.14	Ring Count	72
11.15	Telephone Line Fail Options	73
11.16	Communication Options 1	73
11.17	Communication Options 2	74
11.18	Communication Options 3	75
11.19	A-Link Plus Options	75
11.20	Domestic Dialing	76
11.20.1	Domestic Dialing Function	76
11.20.2	Setting Up and Programming Domestic Reporting	77
11.21	Reporting Formats	77
11.21.1	Contact ID Format	78
11.21.2	SIA Format	78
11.21.3	System Reporting List	79
<b>12</b>	<b>Access</b>	<b>84</b>
12.1	Installer Code	84
12.2	User Codes	84
12.3	User Code Priority	86

<b>13</b>	<b>Zone Information</b>	<b>88</b>
13.1	Day Alarm Information	88
13.1.1	Day Alarm Resetting	88
13.1.2	Day Alarm Latching	88
13.1.3	Day Alarm Operation	88
13.2	EOL Resistor Value	89
13.3	Zone Programming	90
13.3.1	Zone Defaults	90
13.3.2	Zone Types	94
13.3.3	Zone Pulse Count	96
13.3.4	Zone Pulse Count Time	97
13.3.5	Zone Options 1	97
13.3.6	Zone Options 2	98
13.3.7	Zone Report Options	99
13.3.8	Keyswitch Zone Options	100
13.4	Swinger Shutdown Count for Siren	101
13.5	Swinger Shutdown Count for Report	102
13.6	STAY Mode 2 Automatically Bypass Zones	102
13.7	Zone Status Reporting Options	103
<b>14</b>	<b>RF Information</b>	<b>104</b>
14.1	RF Supervision Time	104
14.2	Anti-Jamming Sensitivity	104
14.3	RF Receiver	105
14.4	RF Options	105
14.5	RFID	105
14.5.1	RF Keyfob RFID	106
14.5.2	RF Device RFID	106
14.5.3	RF Reapter RFID	107
<b>15</b>	<b>System Reporting Information</b>	<b>108</b>
15.1	Arm/Disarm Reporting Options	108
15.2	Codepad Reporting Options	108
15.3	Access Denied	108
15.4	System Status Reporting Options	109
15.5	Test Reporting Time	109
15.6	Test Reporting Options	110
15.7	Reports	110
15.7.1	Zone Tamper Report	110
15.7.2	Walk Test Report	110
15.7.3	Bypass Report	110
15.7.4	Trouble Report	110
15.7.5	Sensor Watch Report	111
15.7.6	Alarm Restore Code	111
15.7.7	RF Receiver Trouble Report	111
15.7.8	RF Receiver Trouble Restore Report	111
15.7.9	RF Low Battery Report	111
15.7.10	Arm/Disarm Reports	111
15.7.11	Codepad Duress Report	111
15.7.12	Codepad Panic Report	112
15.7.13	Codepad Fire Report	112

15.7.14	Codepad Medical Report	112
15.7.15	AUX Power Supply Fail Report	112
15.7.16	AUX Power Supply Fail Restore Report	112
15.7.17	AC Fail Report	112
15.7.18	AC Fail Restore Report	113
15.7.19	Low Battery Report	113
15.7.20	Low Battery Restore Report	113
<b>16</b>	<b>Programmable Outputs</b>	<b>114</b>
16.1	Output Programming	114
16.2	Output Event Types	120
16.3	Output Polarity	127
16.4	Output Timing	128
16.5	Pulsing Polarities	129
16.6	One-Shot Polarities	129
<b>17</b>	<b>System Event Timers</b>	<b>130</b>
17.1	Programming Entry/Exit Times	130
17.2	Entry Time 1	130
17.3	Entry Time 2	130
17.4	Exit Time	130
17.5	Entry Guard Time for STAY Mode	131
17.6	Delay Alarm Reporting Time	131
17.7	Sensor Watch Time	131
17.8	Codepad Lockout Time	132
17.9	Siren Run Time	132
17.10	Siren Sound Rate	132
17.11	Auto Arming Pre-Alert Time	132
17.12	Auto Arming Time	133
17.13	Auto Disarming Time	133
17.14	Kiss-Off Wait Time	133
17.15	Speaker Beep Volume	133
<b>18</b>	<b>System and Consumer Options</b>	<b>134</b>
18.1	System Options 1	134
18.2	System Options 2	135
18.3	System Options 3	135
18.4	System Options 4	136
18.5	Consumer Options 1	137
18.6	Consumer Options 2	138
18.7	Consumer Options 3	138
<b>19</b>	<b>Partitioning</b>	<b>140</b>
19.1	Programming	140
19.1.1	Partitioning Options 1	140
19.1.2	Partitioning Options 2	140
19.2	Partition Allocations	141
19.2.1	Zone Area Assignments	141
19.2.2	Codepad assignment	142
19.2.3	User code area assignments	142
<b>20</b>	<b>Text Information</b>	<b>144</b>

# 1 Introduction

This section includes an introduction to documents for this product and other document-related instructions.

## 1.1 About documentation

This document contains instructions for a trained installer to properly install, configure, and operate this control panel, and all optional peripheral devices. Review this document before beginning the installation to determine the hardware and wiring requirements for the features used.

Throughout this document, the words “control panel ” refer to all control panels covered by this document (Solution 2000/3000).

### Notifications

This document uses Notices, Cautions, and Warnings to draw your attention to important information.



#### Notice!

These include important notes for successful operation and programming of equipment, or indicate a risk of damage to the equipment or environment.



#### Caution!

These indicate a hazardous situation which, if not avoided, could result in minor or moderate injury.



#### Warning!

These indicate a hazardous situation which, if not avoided, could result in death or serious injury.

#### Copyright

This document is the intellectual property of Bosch Security Systems, Inc. and is protected by copyright. All rights reserved.

#### Trademarks

All hardware and software product names used in this document are likely to be registered trademarks and must be treated accordingly.

## 1.2 Bosch Security Systems, Inc. product manufacturing dates

Use the serial number located on the product label and refer to the Bosch Security Systems, Inc. website at <http://www.boschsecurity.com/datecodes/>.

The following image shows an example of a product label and highlights where to find the manufacturing date within the serial number.





 **BOSCH**

**Model Number**  
Mat/N: F01Uxxxxxx

 **N663**

7  9  
82695 11xxx

8  7  
717332 311xxx  
09216082027193xxxx

PRODUCT QTY= 1

## 2 System Overview

### 2.1 Product Matrix

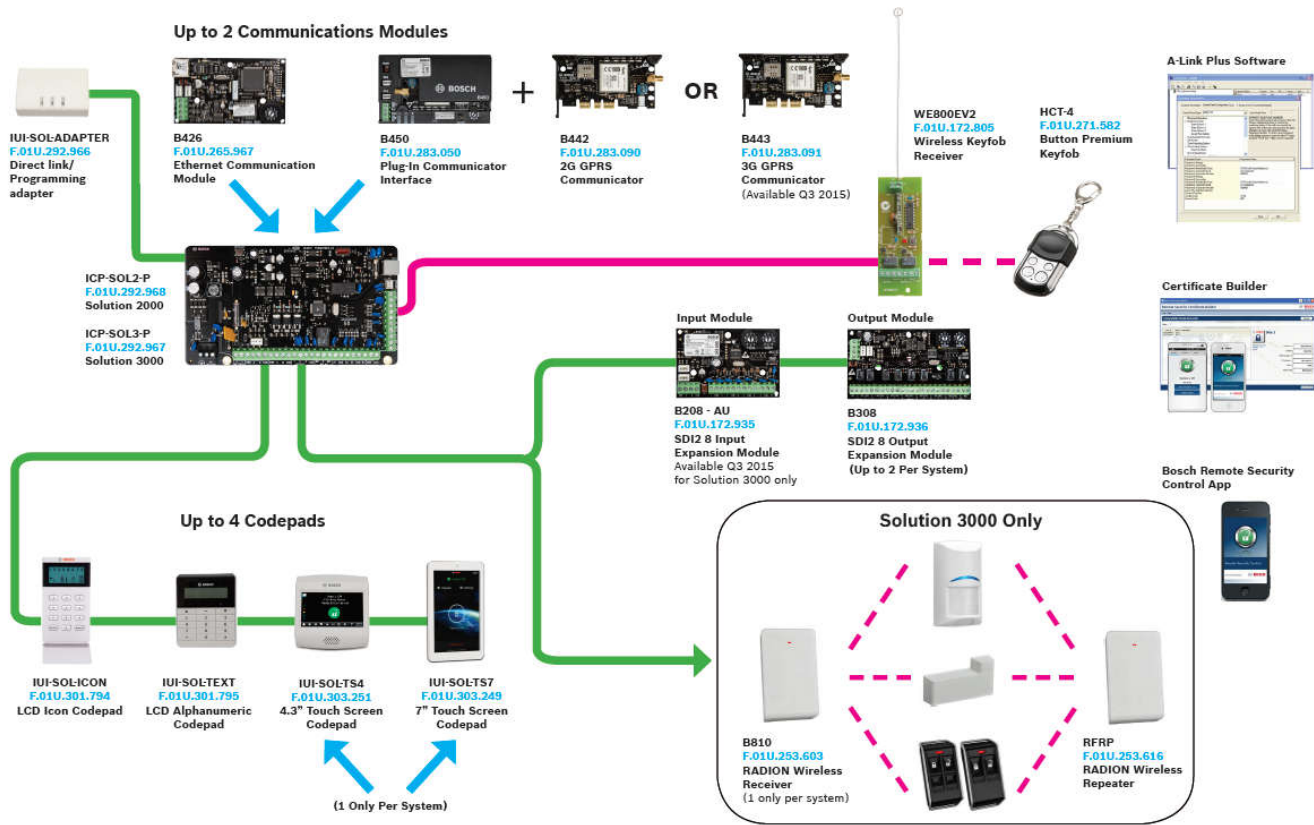

Figure 2.1: Product Matrix 2015

### 2.2 Configuration and Parts

This section lists each control panel's capacities and a parts list.

#### 2.2.1 Control panel capacities

Features	Solution 2000	Solution 3000
Number of users	32	32
Number of zones	4+4 (ZD)	8+8 (ZD)
Number of areas/partitions	2	2
Number of on-board outputs	4	4
Number of codepads	4	4
Number of B308 Octo-output modules	2	2
Number of B426 IP communicators	2	2
Number of B442 or B450 GPRS communicators	2	2
Number of WE800EV2 receivers	1	1

Features	Solution 2000	Solution 3000
Number of RADION receivers	0	1
Number of RADION repeaters	0	8

## 2.2.2

### Parts list

Control panels ship assembled from the factory with the following parts:

#### Literature

- *Control Panels (Solution 2000 / Solution 3000 ) Quick Reference Guide*
- *Control Panels (Solution 2000 / Solution 3000 ) User Guide*

#### HW pack

- EOL resistors
- Battery wires
- PSTN lead
- Screws

#### Assembly

- PC board

## 2.2.3

### Order separately

Order the accessories listed below to aid in the installation of your control panel. If you ordered your control panel in a kit, you might already have these parts.

Accessory Type	Solution 2000	Solution 3000
Codepads	Touchscreen, IUI-SOL-ICON, IUI-SOL-TEXT	Touchscreen, IUI-SOL-ICON, IUI-SOL-TEXT
Keyfobs	HCT-4	HCT-4, RFKF-TB/RFKF-FB
Octo-output modules	B308	B308
Receivers	WE800EV2	WE800EV2, B810
Repeaters		RFRP
Detectors	Wired detectors	Wired detectors, RADION wireless detectors
Software	A-Link Plus	A-Link Plus
Ethernet communication modules	B426	B426
GPRS communication modules	B442, B450	B442, B450
Transformer	TF008-B	TF008-B

#### Other accessories:

Keyswitches  
 Battery  
 Siren  
 Strobe  
 RJ11 PSTN terminal  
 Control Panel Enclosure

## 3 Installation workflow

Before installing and operating the control panel, read these instructions. Failure to follow these procedures may cause the device not to function properly. Bosch Security Systems Inc. is not responsible for any devices that are improperly installed, tested, or maintained. This document does not contain special information about local requirements and safety issues. Information on such issues is provided only to the extent that it is needed for operation of the device. Ensure that you are familiar with all safety-related processes and regulations in your area. This also includes how to act in the event of an alarm and the initial steps to take if a fire breaks out. The operating instructions should always be available on site. It is a required part of the system and must be given to the new owner if the system is ever sold.

Use the workflow and checkboxes below as you complete steps.

- Install the enclosure**
- Install the control panel**
- Install and wire for telephone communication**
- Install and wire for IP communications**
- Install and wire the transformer**
- Install and wire arming devices**
- Install and wire outputs**
- Install and wire inputs**
- Complete the installation**

### See also

- *Install the transformer, page 23*
- *Communication Information, page 65*
- *B426 Conettix Ethernet Communication Modules, page 20*
- *B450 Conettix Plug-in Communicator Interfaces, page 20*
- *Codepads, page 13*
- *RADION keyfobs, page 18*
- *Keyswitches, page 22*
- *WE800EV2 receiver, page 17*
- *B308 Octo-output Module, page 19*

## 4 Accessories

Bosch Security Systems, Inc. manufactures a number of accessories that can be used in conjunction with the control panel. These devices enhance certain features to make the system extremely flexible.

Some sections include basic installation instructions. For detailed installation instructions, refer to the Installation Guide that came packaged with the device.

### 4.1 Codepads

The Solution 2000/3000 control panels support two types of codepads: a text LCD codepad (IUI-SOL-TEXT) and an icon LCD codepad (IUI-SOL-ICON).

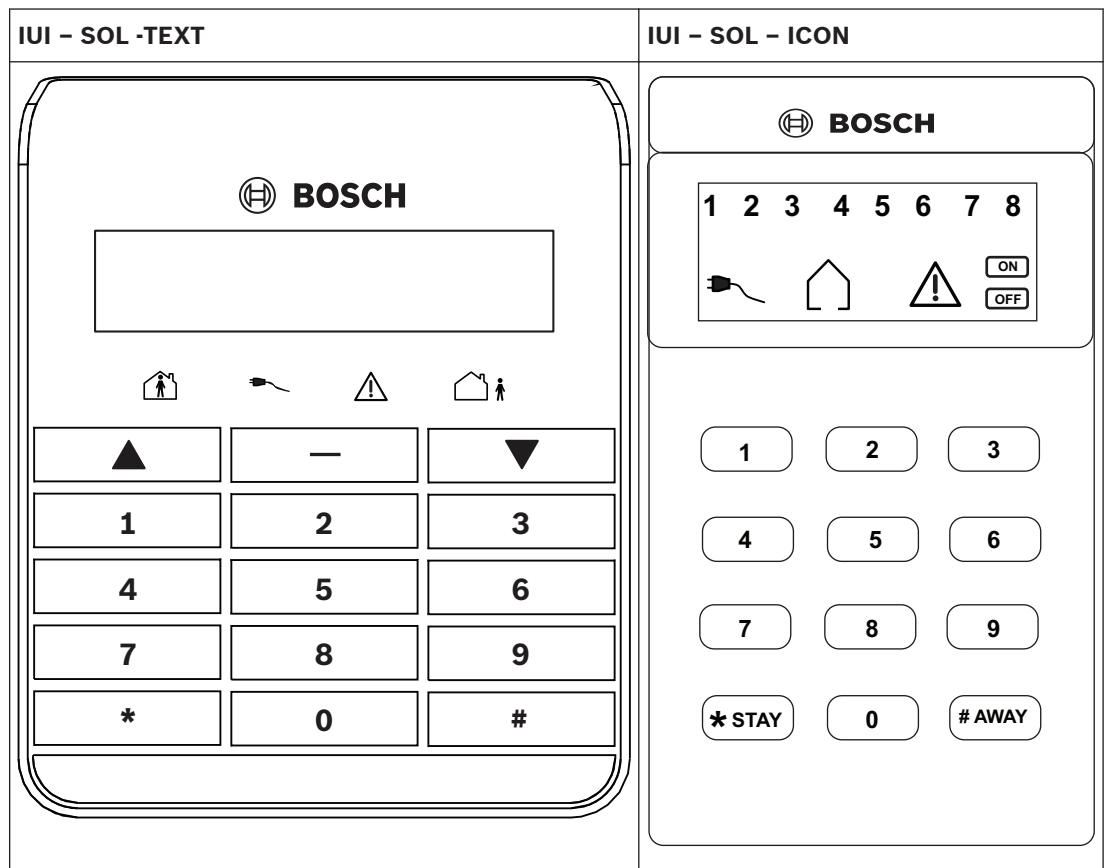

#### Installation

Set the address switches for the proper address, mount the mounting plate, wire to the control panel, and attach the codepad to the mounting plate.



#### Notice!

Do not remove the spring from the tamper switch on the IUI-SOL-ICON. Removing the spring will cause a Codepad Tamper Trouble and a report will be sent if configured to do so.

#### Set the address

The IUI-SOL-TEXT and IUI-SOL-ICON have 6 DIP switches that support SDI2 addresses 01 to 16. DIP switches determine the address for the codepad. The control panel uses the address for communications. Use a ballpoint pen to set the switches.

If multiple codepads reside on the same system, each codepad must have a unique address. The Solution 2000/3000 control panels support up to 4 codepads, addresses 01-04. DIP switch address settings greater than 4 prevent the codepad from processing messages received on the SDI2 bus and the option bus. Any change to the DIP switch requires a power cycle or software reboot of the module for the new external address to be read.

DIP Switch Codepad Address	DIP Switch Number					
	1	2	3	4	5	6
1	On	Off	Off	Off	Off	On
2	Off	On	Off	Off	Off	On
3	On	On	Off	Off	Off	On
4	Off	Off	On	Off	Off	On

**Table 4.1: Codepad DIP switch address settings**

**Install the module**

1. Use the provided anchors and screws to mount the codepad base on the wall.
2. Pull the necessary wiring through the mounting plate.

**Wire to the control panel**

Wire the codepad to the control panel using the control panel terminals labeled R, Y, G, B (PWR, A, B, COM). Connect them to the codepad terminals labeled R, Y, G, B. Connect codepads to the SDI2 data bus by parallel wire run from the control panel to each codepad, wire from codepad to codepad, or a combination of the two. Use a maximum of 7500 ft (2286 m) of 22 AWG (0.8 mm) wire for all devices connected to the SDI2 bus combined.

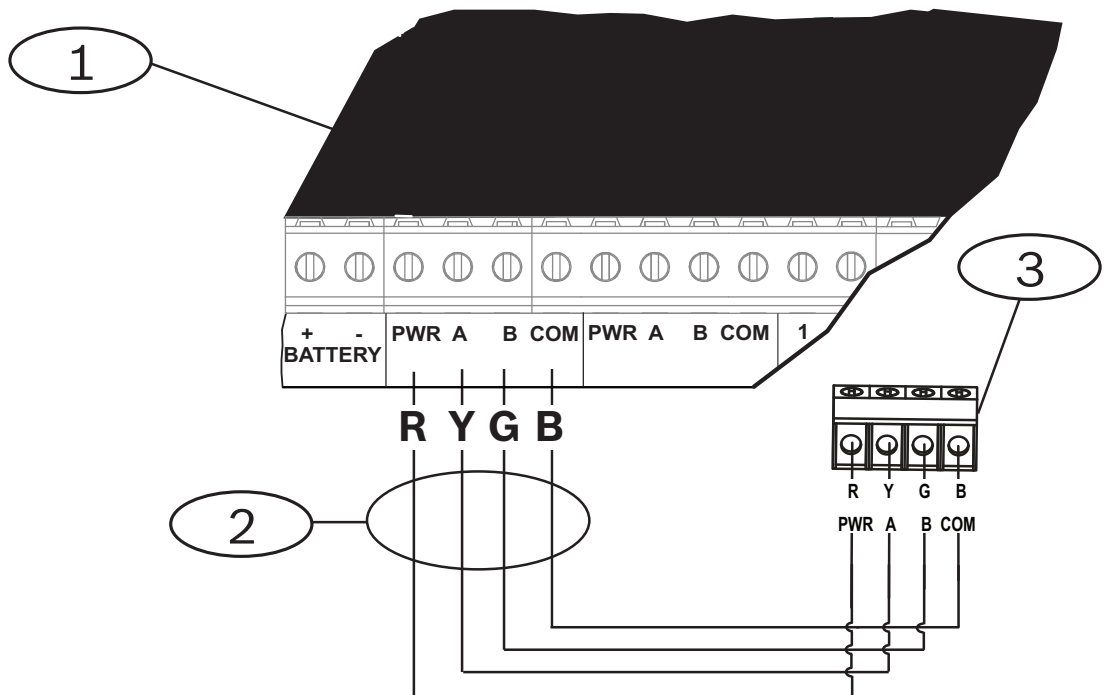

Callout - Description
1 – Control panel
2 – Terminal wiring
3 – Codepad's wiring terminal block

### 4.1.1

#### Installer Menu

Use the menu tree below to program the control panel from the IUI-SOL-TEXT codepad. To program the control panel from the IUI-SOL-ICON, use the programming address indicated in brackets [ ] next to each command as shown in the Menu Tree.

Example:

##### To program Exit Time using the IUI-SOL-TEXT

Method 1: By Text Menu

1. Enter the Installer Code, followed by [-] or [#] key (for example, [1234#]),
2. Then press keys [3], [1], [3] to enter [Exit time] and program the exit time.

Method 2: By address programming

1. Enter the Installer Code, followed by [-] or [#] key (for example, [1234#]),
2. Press [8] [1] to enter address programming.
3. Press [470 #] to enter Exit Time address to program.

##### To program Exit Time using the IUI-SOL-ICON

Enter the Installer Code followed by [#] key, then press [470 #] to enter Exit Time address to program.

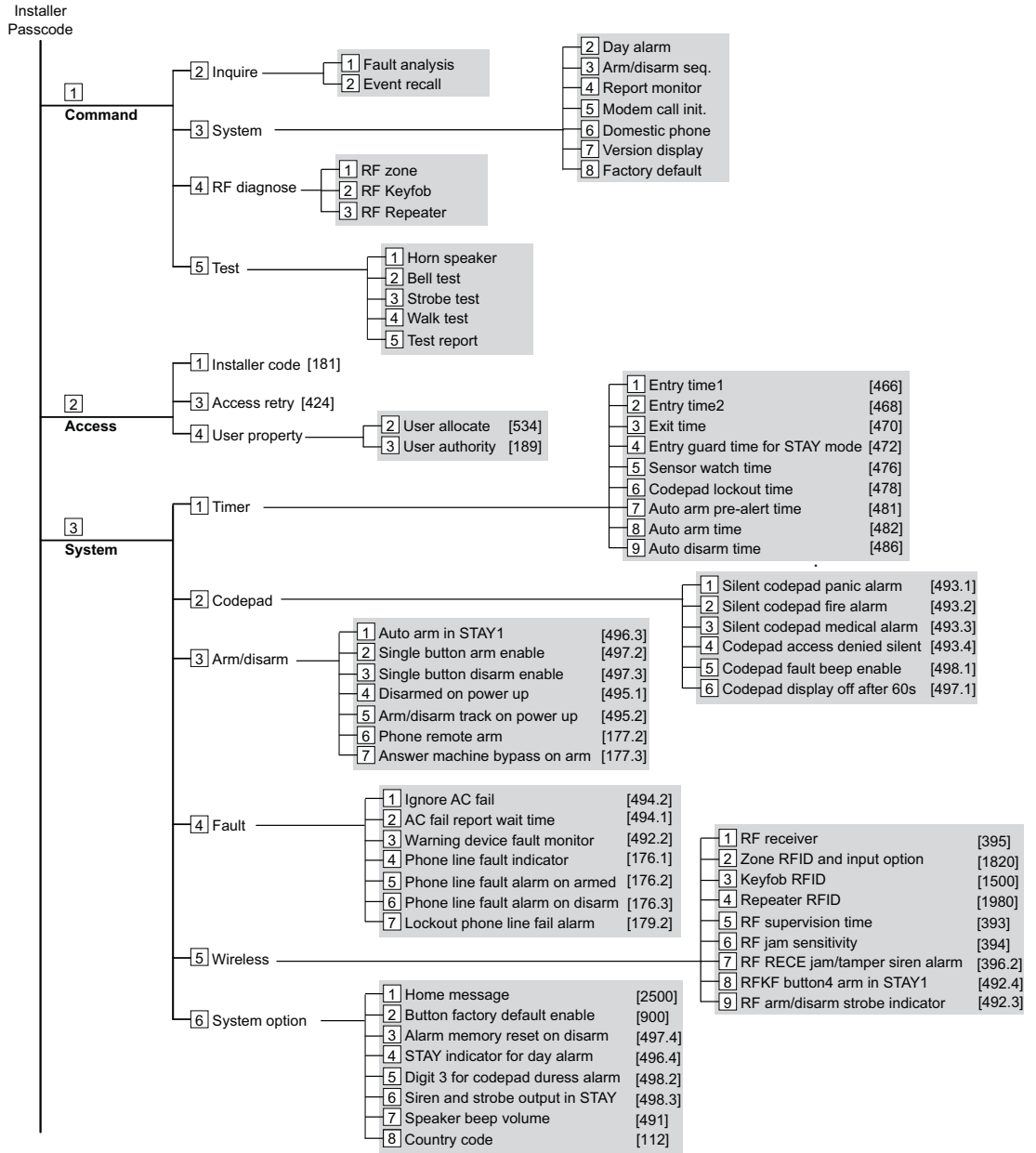



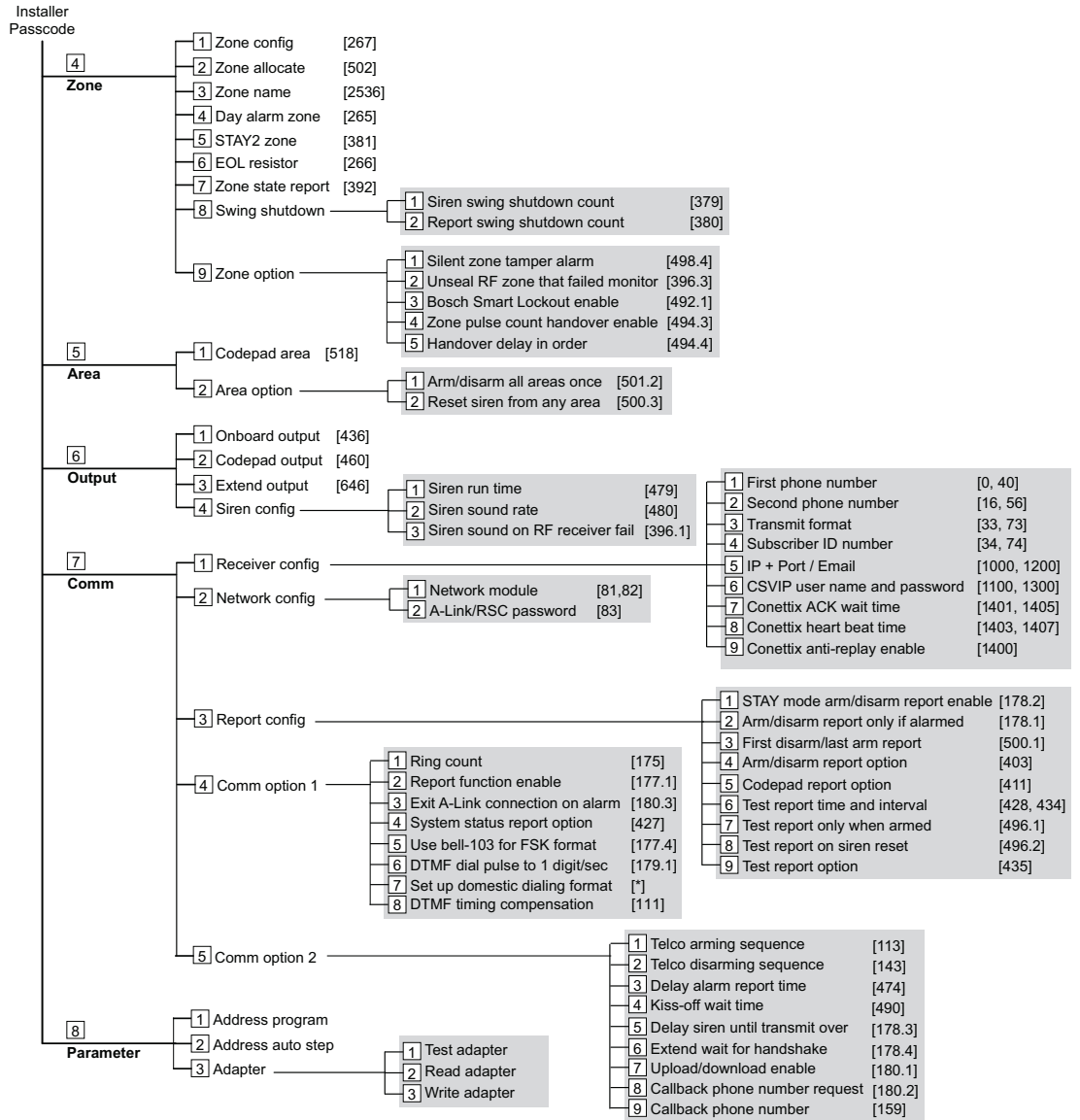

\* Refer to *Command 965 - Set up Domestic Dialing Format*, page 26.

## 4.2 WE800EV2 receiver

The WE800EV2 is designed to provide a convenient ON/OFF control for the Solution 2000/3000 series control panel. Provision is also made for the control of up to two (2) external devices via on-board relays.

### Install the module

1. Remove the small knockout in the Solution 2000/3000 control panel for the antenna and insert the supplied rubber grommet.
2. Install the WE800EV2 PCB in the control panel with the top of the PCB in the slot provided at the top of the case and secure with the provided screw at the bottom of the PCB.
3. Thread the antenna wire through the grommet into the “ANT” terminal.

### Wire to the control panel

Connect the 3 pin plug to the jumper labeled WE800 on the control panel. Note that the connector will only install one way. If the relays are to be used, a wire will need to be connected from the +12V terminal on the WE800EV2 to a +12 terminal on the control panel.

### Add/delete keyfobs



#### Notice!

When purchasing a WE800EV2 kit, the keyfobs supplied are already learned to the WE800EV2 with both relays set for momentary operation. If a different relay set-up is required, delete the keyfobs, then add them back again.

To add keyfobs:

1. Press the Learn/Delete switch once. Note that the LED will flash rapidly.
2. Press the button on the keyfob to be learned that corresponds to the desired relay function.
  - Button 1 – Both outputs momentary
  - Button 2 – Output 1 toggling. Output 2 momentary.
  - Button 3 – Output 2 toggling. Output 1 momentary.
  - Button 4 – Both outputs toggling
3. Repeat for additional keyfobs.
4. Press the Learn/Delete button when finished adding keyfobs to complete the process.

To delete keyfobs:

Press and hold the Learn/Delete switch. Note that the LED will light and then extinguish after 4 seconds. The EEPROM is now erased. Individual keyfob deletion is not possible.

## 4.3 HCT-4 keyfob

This Button Premium Keyfob can be used in conjunction with the WE800EV2 RF Receiver to operate the system remotely.

It can remotely arm and disarm the system in AWAY Mode or STAY Mode 1 and can activate remote Panic Alarms. It can also operate outputs such as garage doors, swimming pool pumps, or outside lights.

## 4.4 RADION receiver B810

The B810 is a wireless receiver that connects RADION wireless peripherals such as the motion detectors, keyfobs, panic buttons, repeaters, and more, to supported Bosch control panels using the SDI2 Bus connection.

For more information, refer to the installation and operation manuals for this product.

## 4.5 RADION keyfobs

RADION keyfob allows you to arm or disarm the security system, or send a panic alarm. The control panels support two RADION keyfob models, RFKF-FB and RFKF-TB, that communicate with the control panel using the RADION receiver SD. On the four-button version, two option buttons are user-defined to perform additional functions. To operate these buttons, simply press and hold either button for at least one sec in order for the desired feature to work.

#### Panic alarm

The keyfob sends a panic code to your monitoring company if your security system is programmed to do so. Press both the lock and unlock buttons simultaneously for more than 600 milliseconds to send a panic alarm.

**LED indicator**

The LED flashes to indicate a signal was sent to your security system.

## 4.6 RADION repeater

RADION repeater receives transmissions from RADION transmitters and re-transmits them to improve transmitted message reliability and range for compatible transmitters and its assigned compatible receiver.

For more information, refer to the installation and operation guides for this product.

## 4.7 RADION detectors

For more information regarding the sensors supported by the Solution 3000 control panel, refer to the installation and operation manuals for the B810 wireless receiver.

**See also**

– *Add or Delete RF Wireless Devices, page 39*

## 4.8 B308 Octo-output Module

The B308 Octo-output Module is a supervised device that provides 8 programmable outputs (Form C relays) and connects to control panels through the SDI2 bus. Each output provides dry contact switching rated for a maximum of 1.0 A at 24 VDC. The outputs are accessed through on-board screw terminal connections. The address switches are used to set the module's SDI2 address. Control panel programming determines each output's response to specific events. The B308 receives serial data from the control panel and activates outputs in response to control panel conditions and settings. Outputs can be programmed for remote control from a control panel codepad or computer (A-Link) or smartphone application (RSC).

**Set the address**

Two address switches determine the address for the B308 Octo-output Module. The control panel uses the address for communications. Use a slotted screwdriver to set the two address switches. Set the address switches per the control panel configuration.

The module's address switches provide a tens and ones value for the module's address. Set the tens switch to 0 and the ones digit 1 for module 1 ; set the tens switch to 0 and the ones digit 2 for module 2.

**Notice!**

The module reads the address switch setting only during power up. If you change the switches after you apply power to the module, you must cycle the power to the module in order for the new setting to be enabled.

**Install the module**

After you set the address switches for the proper address, install the module in the enclosure. Mount the module into the enclosure's 3-hole mounting pattern using the supplied mounting screws and mounting bracket.

**Notice!**

Remove all power (AC and battery) before making any connections. Failure to do so might result in personal injury and/or equipment damage.

**Wire to the control panel**

When you wire the module to a control panel, use the module's terminal strip labeled with PWR, A, B, and COM.

**LED descriptions**

The module includes one blue heartbeat LED to indicate that the module has power and to indicate the module's current state.

Flash pattern	Function
Flashes once every 1 second	Indicates normal operation state.
3 quick flashes every 1 second	Indicates the module is in a "no communication" state resulting in an SDI2 communication error.
ON steady	A trouble condition is exist..
OFF steady	Module is not powered or some other trouble condition is prohibiting the module from controlling the heartbeat LED.

## 4.9 B426 Conettix Ethernet Communication Modules

The B426 Conettix Ethernet Communication Module is a four-wire powered SDI, SDI2, or Option bus device that provides two-way communication with compatible control panels over IPv4 or IPv6 Ethernet networks.

Typical applications include:

- Reporting and path supervision to a Conettix Communications Receiver/Gateway.
- Remote administration and control with A-Link Plus or our Remote Security Control application for handheld devices.
- Connection to building automation and integration applications.

The B426 is built for a wide variety of secure commercial and industrial applications. Flexible end-to-end path supervision, AES encryption, and anti-substitution features make B426 desirable for high security and fire monitoring applications. It is capable as a stand-alone path or it can be used in conjunction with another communication technology. For Fire Monitoring applications, the B426 meets UL864 and NFPA72 standards for Single Communication Technology with approved Bosch control panels.

## 4.10 B450 Conettix Plug-in Communicator Interfaces

The B450 Conettix Plug-in Communicator Interface is a four-wire powered SDI2, SDI, or option bus device that provides two-way communication with compatible control panels over commercial cellular networks using a plug-in communicator (available separately).

Use the B450 in combination with a plug-in communicator for primary or backup alarm communication, remote control panel programming and other remote applications. The B450 supports Conettix IP protocol with full authentication, 256 bit AES encryption and resistance to Denial of Service attacks. Use the B450 to add cellular network communications to existing or new commercial security and fire installations.

**Switch addressing**

Use the address switch to assign a bus address or setup for USB or SMS configuration where required. The address switch allows bus address selection.

### Configuration

For most installations, the default B450 settings allow installation with no device programming required. For customized network settings, the B450 supports a USB configuration menu, or configuration via SMS.

When the B450 is running in version 3 compatibility mode, it reports its module type as a B426. Networking parameters can be configured using A-Link. When the cellular specific parameters need to be modified, use USB or SMS to configure the module directly.

When the B450 is running in version 4 compatibility mode, it reports its own product type. Both networking parameters and cellular specific parameters can be configured using A-Link.

### LEDs

Three LEDs provide status and troubleshooting information about the module and its connection.

LED	Description
Heartbeat	Indicates the system status of the B450 and its connection to the control panel.
RX	Indicates when an inbound packet is received on the bus.
TX	Indicates when an outbound packet is transmitted on the bus.

### Mounting considerations

Find a location with acceptable signal strength on your wireless network. Mount the B450 Conetix Plug-in Communicator Interface into the interior of a compatible enclosure via the 3-hole mounting pattern using the supplied mounting screws.

### Wiring considerations

The B450 connects to a control panel using a data bus connection via the module's terminal strip, or the module's interconnect wiring connectors.

For data bus powered installations outside the compatible control panel enclosure, follow the maximum wiring distances in the technical specifications. For further installations power from a compatible auxiliary power supply.

## 4.11

### A-Link Plus Software

You can program or control the Solution 2000/3000 control panels remotely using A-Link plus Software. This software allows you to change your customer's control panel without leaving your office, which improves customer service and saves your time and money. For locations where a control panel is installed hundreds of kilometers from your office, the Upload/Download feature is invaluable.

A-Link plus software running in windows 7 OS: When selecting the control panel type during the setup of a new customer database in the A-Link plus Software. The software version is v4.7 or later and the control panel type is Solution 2000 or Solution 3000.

When you add a new customer in the A-Link plus Software, the "Installer code" and the "A-Link Plus / RSC password" must match the values programmed in the control panel for synchronization during connection to the control panel. If this location does not match those of the control panel, the software and the control panel cannot be synchronized.

### Minimum System Requirements

System Component	Minimum Requirement
Processor	Intel PIII 1.5 GHz or higher
Operating System	Microsoft Windows 8 Microsoft Windows 7 Microsoft Windows Vista Microsoft Windows XP with SP1,2 or 3 (In Vista and XP, Microsoft VC++2008 Redistributable Package shall be installed)
Hard Drive Free Space	At least 4GB
Memory	At least 256 MB
Mouse	Windows compatible mouse
Video	Standard VGA monitor capable of supporting a resolution of 1024x768 or higher.

For instructions on installing and using A-Link Plus, refer to the A-Link Plus User Guide.

**See also**

- *A-Link Plus Application, page 58*

## 4.12 Remote Security Control

Remote Security Certificate Builder (RSCB) is an account management utility for Microsoft Windows operating systems. It is designed to create certificates granting permissions to users to access specific control panels with Remote Security Control (RSC), which is an app for Android and Apple iOS devices.

Downloading the installation files:

1. Go to the Bosch website ([us.boschsecurity.com](http://us.boschsecurity.com)).
2. Click on the Products tab and select Intrusion Alarm Systems.
3. On the right side of the page, under Online Tools, click the Remote Security Certificate Builder link.
4. After reviewing the required prerequisites, click Install.
5. Save the install file to your computer hard drive.

The Remote Security Certificate Builder link also includes the documentation needed to install, configure, and use RSCB and the RSC application.

## 4.13 Keyswitches

Connect the keyswitch to any zone programmed as keyswitch zone, refer to *Zone Types, page 94*.

Program Keyswitch Zone Options, refer to *Keyswitch Zone Options, page 100*.

When the Zone Type is programmed as keyswitch, Zone Options 1 replaces Keyswitch Zone Options. A keyswitch zone can arm/disarm or momentary arm/disarm the area in STAY Mode 1 or AWAY Mode as configured. A keyswitch zone can only arm/disarm the area it belongs to. Its zone number is reported as a user code number.

## 4.14 TF008 Plug Pack (TF008-B)

The TF008 plug pack is used with control panels.

The plug pack includes built-in thermal fuses that blow during overload or fault conditions to eliminate a possible fire threat due to excessive heat buildup inside the casing.

The plug pack incorporates a three-wire flying lead that enables a MAINS earth connection between the equipment and the plug pack. This connection might be required for lightning protection on equipment connected to phone lines or for safety reasons such as earthing of metal enclosures.

#### 4.14.1 Install the transformer

**Caution!**

Do not short-circuit the terminals of the transformer: Shorting the terminals opens the internal fuse, causing permanent failure. Connect the transformer to the 18-22 VAC terminals of the control panel before plugging it into the power source.

**Notice!****Plan Ahead**

Route telephone, SDI2 bus wiring, and sensor loop wiring away from any AC conductors, including the transformer wire. AC wiring can induce noise and low level voltage into adjacent wiring.

1. Use 18 AWG (1.02 mm) wire minimum (12 AWG [2 mm] maximum) and connect the transformer to the control panel. Make the wire length as short as possible. Do not exceed 50 ft (15 m).
2. Connect the wire to the control panel.
3. Connect the wire to the transformer.
4. Plug the transformer into the power outlet.

#### 4.15 DLA

Direct link adapter IUI-SOL-ADAPTER is one of accessories that can be used in conjunction with the SDI2 Bus control panel.

DLA works with control panel via SDI2 bus cable.

- Copy the control panel memory to the DLA.
- Copy the DLA data to the control panel memory.
- Control panel firmware upgrade.

A-Link Plus controls the control panel remotely via DLA.

## 5 Configuration

### 5.1 Installer Commands

When working with an ICON codepad, there are nine commands in Installer's Programming Mode. To issue a command, enter the command number and press [#].

When working with a text codepad, select the menu and issue a command after entering the Installer Menu.

Command	Description
958	Exit from Installer's Programming Mode without saving changes
959	Test IUI-SOL-ADAPTER
960	Exit from Installer's Programming Mode with saving changes and system reset
961	Reset the control panel to factory defaults
962	Copy the control panel memory to IUI-SOL-ADAPTER
963	Copy IUI-SOL-ADAPTER data to the control panel memory
965	Set up domestic dialing format
966	Enable/disable the automatic stepping of locations during programming
999	Display the control panel firmware version number

**Table 5.1: Installer's Programming Commands**

#### 5.1.1 Command 958 - Exit from Installer's Programming Mode without saving changes

This command exits from Installer's Programming Mode. You can exit from Installer's Programming Mode from any location.

**To exit from Installer's Programming Mode:**

Enter [9 6 0 #]. The system returns to the disarmed state. When using the codepad, the STAY and AWAY indicators are extinguished.

#### 5.1.2 Command 959 - Test IUI-SOL-ADAPTER

This command initiates a test of the direct link adapter. You can only use the IUI-SOL-ADAPTER Direct Link Adapter with the control panel.

The direct link adapter test is non-destructive, and any data in the direct link adapter remains after the test is completed. One long beep indicates that the direct link adapter test failed.

Two beeps indicates a successful test.

If you remove the direct link adapter before the test is finished, the direct link adapter data becomes corrupt. Do not remove the direct link adapter while the activity LED is lit or pulsing rapidly.

**To test the direct link adapter:**

1. Enter the Installer Code (the default is 1234) and press [#] to enter Installer's Programming Mode. Two beeps sound and the STAY and AWAY indicators flash on the codepad to indicate you entered Installer's Programming Mode. The codepad displays the data stored in Location 000.



2. Connect the direct link adapter to the Bosch SDI2 Bus pins at the bottom of the control panel printed circuit board.
3. Enter [9 5 9 #]. Two beeps sound after a successful test of the direct link adapter. A long beep indicates that the direct link adapter data is corrupt and must be erased to clear the corrupt data.
4. Enter [9 6 0 #] to exit from Installer's Programming Mode. The STAY and AWAY indicators are extinguished on the codepad and the system returns to the disarmed remote state.
5. Remove the direct link adapter from the control panel. Failure to exit from Installer's Programming Mode before removing the direct link adapter can corrupt the data in the direct link adapter.

When working with a text codepad, go to Menu 831 [Test adapter] to test the DLA.

### 5.1.3 **Command 960 - Save and exit from Installer's Programming Mode**

This command saves and exits from Installer's Programming Mode. You can exit from Installer's Programming Mode from any location.

**To exit from Installer's Programming Mode:**

Enter [9 6 0 #]. The system returns to the disarmed state. When using the codepad, the STAY and AWAY indicators are extinguished.

### 5.1.4 **Command 961 - Reset the Control Panel to Factory Default Settings**

This command resets the control panel to factory default values. You can reset the control panel from any location.

**To reset the control panel to factory defaults:**

1. Enter the Installer Code (the default is 1234) and press [#] to enter Installer's Programming Mode. Two beeps sound and the STAY and AWAY indicators flash on the codepad to indicate that you entered Installer's Programming Mode. The codepad displays the data stored in Location 000.
2. Enter [9 6 1 #]. Two beeps sound and the system is reset to the factory default values. When working with a text codepad, go to Menu 138 [Factory default] to reset the system to factory default settings.

### 5.1.5 **Command 962 - Copy the Control Panel Memory to IUI-SOL-ADAPTER**

This command copies the control panel memory to the direct link adapter. You can only use the IUI-SOL-ADAPTER Direct Link Adapter with the control panel.

**To copy the control panel memory to the direct link adapter:**

1. Enter the Installer Code (the default is 1234) and press [#] to enter Installer's Programming Mode. Two beeps sound and the STAY and AWAY indicators flash on the codepad to indicate you entered Installer's Programming Mode. The codepad displays the data stored in Location 000.
2. Connect the direct link adapter to the Bosch SDI2 Bus pins at the bottom of the control panel printed circuit board.
3. Enter [9 6 2 #]. Two beeps sound after the control panel memory is successfully copied to the direct link adapter. A long beep indicates that the direct link adapter is corrupt and must be erased to clear the corrupt data.
4. Enter command [9 6 0 #] to exit from Installer's Programming Mode. The STAY and AWAY indicators are extinguished on the codepad to indicate the system is disarmed.
5. Remove the direct link adapter from the control panel. Failure to exit from Installer's Programming Mode before removing the direct link adapter can corrupt the direct link adapter.

When working with a text codepad, go to Menu 833 [Write adapter] to copy the control panel memory to the DLA.

### 5.1.6 **Command 963 - Copy IUI-SOL-ADAPTER data to the Control Panel**

This command copies data from the direct link adapter to the control panel. You can only use the IUI-SOL-ADAPTER Direct Link Adapter only with the control panel.

**To copy the direct link adapter memory to the control panel:**

1. Enter the Installer Code (the default is 1234) and press [#] to enter Installer's Programming Mode. Two beeps sound and the STAY and AWAY indicators flash on the codepad to indicate you entered Installer's Programming Mode. The codepad displays the data stored in Location 000.
2. Connect the direct link adapter to the Bosch SDI2 Bus pins at the bottom of the control panel printed circuit board.
3. Enter [9 6 3 #]. Two beeps sound after the direct link adapter's data is successfully copied to the control panel. A long beep indicates that the direct link adapter is corrupt and must be erased to clear the corrupt data.
4. Enter [9 6 0 #] to exit from Installer's Programming Mode. The STAY and AWAY indicators are extinguished on the codepad to indicate the system is disarmed.
5. Remove the direct link adapter from the control panel Failure to exit from Installer's Programming Mode before removing the direct link adapter can corrupt the direct link adapter.

When working with a text codepad, go to Menu 832 [Read adapter] to copy the DLA data to the control panel.

### 5.1.7 **Command 965 - Set up Domestic Dialing Format**

Command 965 simplifies the setup of the domestic dialing format to a one-step operation. Refer to *Domestic Dialing*, page 76 for more information.

**To set up domestic dialing format:**

1. Enter the Installer Code (the default is 1234) and press [#] to enter Installer's Programming Mode. Two beeps sound and the STAY and AWAY indicators flash on the codepad to indicate you entered Installer's Programming Mode. If on a text codepad, go to menu 81 [Address Program]. The codepad displays the data Mode. The codepad displays the data stored in Location 000.
2. Enter [9 6 5 #]. The command automatically sets Receiver 1 to domestic reporting and sets other locations or Receiver 2 only (refer to the table Command 965 Defaults below). No other locations are changed when you issue command 965.
3. If on a text codepad, enter the Installer Code (the default is (1234) and press [#] to enter Installer's Programming Mode. Go to menu 747 [Set Up Domestic Dialing Format], then save and exit.

The transmission format is automatically set for domestic dialing and the Subscriber ID Number set for one identification beep. All reports, except Zone Status reporting and System Status reporting, are allocated to Receiver 1 for domestic dialing.

Zone Status Reports including Zone Bypass, Zone Trouble, Sensor Watch, and Alarm Restore codes, and System Status Reports including AUX Power Supply Fail, AC Fail, Low Battery, and Access Denied Reports are allocated to Receiver 2 and do not report unless Receiver 2 is also set up to report.

Location	Description	Default Value	Setting
033	Transmission Format	4	Domestic
034 and 039	Subscriber ID Number	0, 0, 0, 0, 0, 1	1 Beep
392	Zone Status Reporting Options	2	Receiver 2 only
403	Arm/Disarm Reporting Options	2	Receiver 2 only
424	System Status – Access Denied	6	Access Denied
427	System Status Reporting Options	2	Receiver 2 only
428 to 431, 434	Test Report Time	0, 0, 0, 0, 0	Test Reports
435	Test Reporting Options	1	Receiver 1 only

**Table 5.2: Command 965 Defaults**

### 5.1.8

#### **Command 966 - Enable/Disable the Automatic Stepping of Locations**

This command allows the automatic stepping of locations when programming in Installer's Programming Mode.

Programming with the codepad provides no visual indication that Auto Step Mode is enabled.

##### **To enable the automatic stepping of locations:**

1. Enter the Installer Code (default = 1234) and press [#] to enter Installer's Programming Mode. Two beeps sound and the STAY and AWAY indicators flash on the codepad to indicate you entered Installer's Programming Mode. The codepad displays the data stored in Location 000.
2. Enter [9 6 6 #]. Two beeps sound.

To disable the automatic stepping of locations:

Enter [9 6 6 #]. Two beeps sound.

##### **Example (Auto Step Enabled)**

To enter the Primary Telephone Number 02 (pause) 9672 1055 when auto step is enabled:

1. Press [0 #]. You are positioned at Location 000 (the Primary Telephone Number for Receiver 1).
2. Program the number by pressing: [10 \* 2 \* 13 \* 9 \* 6 \* 7 \* 2 \* 1 \* 0 \* 5 \* 5 \* 0\*]

##### **Example (Auto Step Disabled)**

To enter the Primary Telephone Number 02 (pause) 9672 1055 when auto step is disabled:

Press [0 #].

You are positioned at Location 000 (the Primary Telephone Number for Receiver 1).

To program the number, press:

[10 \* # 2 \* # 13 \* # 9 \* # 6 \* # 7 \* # 2 \* # 1 \* # 0 \* # 5 \* # 5 \* # 0\*]

When working with a text codepad, go to Menu 82 [Adapter auto step] to switch automatic stepping enable/disable.

### 5.1.9

#### **Command 999 - Display the Control Panel Firmware Version Number**

When using the codepad, this command displays the firmware version of the control panel.

##### **To display the control panel firmware version number:**

1. Enter the Installer Code (the default is 1234) and press [#] to enter Installer's Programming Mode. If you are using the codepad, the STAY and AWAY indicators flash to indicate you entered Installer's Programming Mode.

2. Enter [9 9 9 #]. If you are using the codepad, the codepad lights a zone indicator corresponding to the first digit of the version number.
3. Press [\*]. The codepad lights a zone indicator corresponding to the second digit of the version number.
4. Press [\*] again to display the last digit. If the digit is 0, no zone indicator displays. (Example: version 1.1.0, in location from 999 to 997 shows as 110.)
5. Enter [9 6 0 #] to exit from Installer's Programming Mode. The system returns to the disarmed state. If you are using the codepad, the STAY and AWAY indicators are extinguished to indicate the system is disarmed.

When working with a text codepad, go to Menu 137 [Version display] to check the control panel firmware version.

## 5.2 Disable Factory Defaults

This feature prevents the control panel from manually restoring the default settings by the default button and prevents the use of a programming key to automatically download to the control panel when the system is disarmed.

Item	Location	Option	Default	New
Button Default Options	0900	0 = Button Factory Default Enable 15 = Button Factory Default Disabled	0	

Enter the default setting of 0 for Location 900 to restore the control panel to its default settings. Enter 15 for Location 900 to restrict the ability to restore the control panel to its default settings and to require the Installer Code for future control panel programming. If the Installer Code is unknown, you must restore the control panel to your Bosch distributor for exchange. A nominal fee applies for this service.



### Notice!

The use of this feature is not recommended.

If you are required to disable the ability restore the control panel to its default settings, a special procedure eliminates the possibility of accidentally setting this option. You must hold down the default button on the printed circuit board (PCB) when programming this location.

#### To prevent manually restoring the default control panel settings:

1. Enter the Installer Code (the default is 1234) and press [#] to enter Installer's Programming Mode. Two beeps sound and the codepad displays the data programmed in Location 000. If you are using the codepad, the STAY and AWAY indicators flash to indicate you entered Installer's Programming Mode.
2. Enter [9 0 0 #] to move to Location 900.
3. Press and hold the DEFAULT button.
4. Enter [1 5 \*] to program 15 into Location 900.
5. Release the DEFAULT button.
6. Enter [9 6 0 #] to exit from Installer's Programming Mode. The system returns to the disarmed state. If you are using a codepad, the STAY and AWAY indicators are extinguished to indicate that the system is disarmed.

If Location 900 is not programmed as 15, do one of the following procedures to restore the default control panel settings.

**To default the control panel settings using the Installer Code:**

1. Enter the Installer Code (the default is 1234) and press [#] to enter Installer's Programming Mode. Two beeps sound. The STAY and AWAY indicators flash to indicate you entered Installer's Programming Mode.
2. Enter [9 6 1 #]. Two beeps sound after the default control panel settings are restored.
3. Enter [9 6 0 #]. The STAY and AWAY indicators stop flashing and the system returns to the disarmed state.

The control panel default factory settings are restored.

**To restore the default control panel settings using the default button:**

1. Disconnect the AC MAINS supply and the backup battery from the control panel.
2. Press and hold the DEFAULT button.
3. Reconnect the AC MAINS supply to the control panel.
4. Wait 3 to 5 sec and release the DEFAULT button.
5. Enter [2580\*] to disarm the system using the default Master Code.

The control panel default factory settings are restored.

**Notice!**

Do not connect the DLA to control panel when restore the default control panel settings using the DEFAULT button, otherwise the control panel will start firmware upgrading.

## 6 System Operations

This section explains the general operations of the system: arming and disarming the system in the three modes, isolating zones, initiating codepad alarms, and determining a fault. Operations described in this chapter are based on use with the IUI-SOL-ICON codepad. For the IUI-SOL-TEXT codepad, follow the prompts on the codepad display.

### 6.1 Arming the system in AWAY Mode

Arming the system in AWAY Mode is normally performed when you leave the premises and require that all zones are activated in a ready state to detect an intrusion.

There are two different methods to arm the system in AWAY Mode. You can always use method one. You can use method two only if Option 2 is enabled in Location 497 (refer to *Consumer Options 2*, page 138).

If you must isolate a zone (or zones) before arming the system in AWAY Mode, refer to *Isolating zones*, page 34.



#### Notice!

Single button arming in AWAY mode reports as user code number 00.

#### To arm the system in AWAY Mode (method one):

1. Enter your code and press [AWAY].
2. Two beeps sound, the AWAY indicator lights, and Exit Time starts.

#### To arm the system in AWAY Mode (method two):



#### Notice!

Select Option 2 in Location 497 to enable single button arming in AWAY Mode (refer to *Consumer Options 2*, page 138).

1. Press and hold [AWAY].
2. When two beeps sound, release the button. The AWAY indicator lights and Exit Time starts.

If a zone is not sealed at the end of Exit Time, the zone is automatically isolated and its indicator is lit on the codepad. The zone becomes an active part of the system again as soon as it is resealed. For example, if a window is open when Exit Time expires, the window is not an active part of the system until it is closed. Opening the window after Exit Time expires causes an alarm.

#### Forced Arming

Arming the system when a zone is not sealed is known as forced arming. Refer *Zone Options 2*, page 98 to enable forced arming for each zone.

If the AWAY indicator does not light and a long beep sounds when you attempt to arm the system in AWAY Mode, forced arming is not permitted. If this is the case, you seal all zones or manually isolate them before you can arm the system.

### 6.2 Disarming the system from AWAY Mode

When you enter the premises after the system is armed in AWAY Mode, you must disarm the system from AWAY Mode to disable detection devices that activate the sirens, strobe, and bell outputs.

If there was an alarm prior to disarming the system from AWAY Mode, a zone indicator flashes, indicating a previous alarm in that zone.

**To disarm the system from AWAY Mode:**

1. Enter your code and press [AWAY].
2. Two beeps sound and the AWAY indicator is extinguished.

**6.3****Arming the System in STAY Mode 1**

STAY Mode 1 is used when you need to arm the perimeter and unused areas of the premises to detect a would-be intruder entering the premises, while at the same time being able to move freely within an area that is automatically isolated.

Only the installer can program zones to be automatically isolated in STAY Mode 1. Refer to *Zone Options 2, page 98* for more information on setting zones to be automatically isolated in STAY Mode 1.

There are two methods to arm your system in STAY Mode 1. You can always use method one. You can use method two only if Option 2 is enabled in Location 497 (refer to *Consumer Options 2, page 138*).

If the system reports to a base station, it sends a STAY Mode 1 Arm Report (Contact ID Event Code 441).

**Entry Guard Time for STAY Mode**

When arming the system in STAY Mode 1, an optional entry time called Entry Guard Time for STAY Mode can be used to delay the sirens, strobe, and bell outputs if a zone that is not automatically isolated activates an alarm. Entry Guard Time for STAY Mode is the delay time used for all zones, except 24-Hour zones, when the system is armed in STAY Mode 1 or STAY Mode 2. For more information, refer to *Entry Guard Time for STAY Mode, page 131*.

If the Entry Guard Time for STAY Mode is programmed and a zone that was not automatically isolated is activated, the codepad beeps twice per sec until the Entry Guard Time for STAY Mode expires or the system is disarmed. If the alarm is not reset before Entry Guard Time for STAY Mode expires, the strobe, bell, and siren outputs are activated into alarm.

**Notice!**

Single button arming in STAY Mode 1 reports as User Code number 00.

**To arm the system in STAY Mode 1 (method one):**

1. Enter your code and press [STAY].
2. Two beeps sound and the STAY indicator is lit. Exit Time starts.

The indicators for any zones that are programmed to be automatically isolated in STAY Mode 1 begin to flash until Exit Time expires. At the end of Exit Time, the zone indicators are extinguished and the codepad sounds one short beep.

**To arm the system in STAY Mode 1 (method two):**

1. Press and hold [STAY].
2. When two beeps sound, release the button. The STAY indicator is lit and Exit Time starts. The indicators for any zones that are programmed to be automatically isolated in STAY Mode 1 flash until Exit Time expires. At the end of Exit Time, the zone indicators are extinguished and the codepad sounds one short beep.

If a zone is not sealed at the end of Exit Time, the zone is automatically isolated and is lit constantly on the remote codepad. The zone becomes an active part of the system again as soon as it is resealed. For example, if a window is open when Exit Time expires, the window does not become an active part of the system until it is closed. Opening the window after Exit Time expires causes an alarm.

**Forced Arming**

Arming the system when a zone is not sealed is known as forced arming. Refer to *Zone Options 2, page 98* to enable forced arming for each zone.

If the STAY indicator does not light and a long beep sounds when you attempt to arm the system in STAY Mode 1, forced arming is not permitted. If this is the case, you must seal all zones or manually isolate them before you can arm the system.

## 6.4 Disarming the system from STAY Mode 1

There are two methods to disarm the system from STAY Mode 1. You can always use the first method. You can use method two only if Option 4 is enabled in Location 497 (refer to *Consumer Options 2, page 138*).

### To disarm the system from STAY Mode 1 (method one):

1. Enter your code and press [STAY].
2. Two beeps sound and the STAY indicator is extinguished. The system is now disarmed.

### To disarm the system from STAY Mode 1 (method two):

A flashing zone indicator represents a previous alarm in that zone. If this is the case, a valid User Code is required to disarm the system using method one. To enable method two, Option 4 in Location 497 must be enabled.

1. Press and hold [STAY].
2. When two beeps sound, release the button. The STAY indicator is extinguished and the system is disarmed.



### Notice!

Single button disarming from STAY Mode 1 reports as User Code 00.

## 6.5 Arming the system from STAY Mode 2

STAY Mode 2 is used when you need to arm the perimeter and unused areas of the premises to detect a would-be intruder from entering the premises, while at the same time being able to move freely within an area that is automatically isolated.

You can program zones to be automatically isolated in STAY Mode 2 using an Installer Code function (refer to *Installer Code Functions, page 39*) or a Master Code function (*Master Code Functions, page 47*).

If the system reports to a base station, it sends a STAY Mode 2 Arm Report (Contact ID Event Code 456).

### Entry Guard Time for STAY Mode

When arming the system in STAY Mode 2, an optional entry time called Entry Guard Time for STAY Mode can be used to delay the sirens, strobe, and bell outputs if a zone that is not automatically isolated activates an alarm. Entry Guard Time for STAY Mode is the delay time used for all zones, except 24-Hour zones, when the system is armed in STAY Mode 1 or STAY Mode 2. For more information, refer to *Entry Guard Time for STAY Mode, page 131*.

If the Entry Guard Time for STAY Mode is programmed and a zone that was not automatically isolated is activated, the codepad beeps twice per sec until the Entry Guard Time for STAY Mode expires or the system is disarmed. If the alarm is not reset before Entry Guard Time for STAY Mode expires, the strobe, bell, and siren outputs are activated into alarm.



### Notice!

Single button arming from STAY Mode 2 reports as User Code 00.



**To arm the system in STAY Mode 2:**

1. Press and hold [0].
2. When two beeps sound, release the button. The STAY indicator is lit and the Exit Time starts.

The indicators for any zones that are programmed to be automatically isolated in STAY Mode 2 flash until the Exit Time expires. At the end of Exit Time, the zone indicators are extinguished and the codepad sounds one short beep.

If a zone is not sealed at the end of Exit Time, the zone is automatically isolated and is lit constantly on the remote codepad. The zone becomes an active part of the system again as soon as it is resealed. For example, if a window is open when Exit Time expires, the window does not become an active part of the system until it is closed. Opening the window after Exit Time expires causes an alarm.

**Forced Arming**

Arming the system when a zone is not sealed is known as forced arming. Refer to *Zone Options 2, page 98* to enable forced arming for each zone.

If the STAY indicator does not light and a long beep sounds when attempting to arm the system, forced arming is not permitted. If this is the case, you must seal all zones or manually isolate them before you can arm the system.

## 6.6 Disarming the system from STAY Mode 2

There are two methods to disarm the system from STAY Mode 2. You can always use the first method. You can use method two only if Option 4 is enabled in Location 497 (refer to *Consumer Options 2, page 138*).

**To disarm the system from STAY Mode 2 (method one):**

1. Enter your code and press [STAY].
2. Two beeps sound and the STAY indicator is extinguished. The system is now disarmed.

**To disarm the system from STAY Mode 2 (method two):**

A flashing zone indicator represents a previous alarm in that zone. If this is the case, a valid User Code is required to disarm the system using method one. To enable method two, Option 4 in Location 497 must be enabled.

1. Press and hold [0].
2. When two beeps sound, release the button. The STAY indicator is extinguished and the system is disarmed.

**Notice!**

Single button disarming from STAY Mode 2 reports as User Code 00.

## 6.7 Codepad duress alarm

A codepad Duress Alarm is used as a silent holdup alarm when 9 is added to the end of a valid User Code being used to disarm the system.

A Duress Alarm (Contact ID Event Code 121) is useful only if your system reports to a monitoring station because domestic reporting format cannot decipher the type of alarm that occurred. You can select Option 2 in Location 498 to use 3 instead of 9 to activate a Duress Alarm (refer to *Consumer Options 3, page 138*).

## 6.8 Codepad panic alarm

An audible codepad Panic Alarm activates when a user presses either [1] and [3] or [STAY] and [AWAY] simultaneously.

Select Option 1 in Location 493 to program the codepad Panic Alarm as silent (refer to *System Options 2, page 135*). A codepad Panic Alarm transmits Contact ID Event Code 120 if the system reports to a base station receiver.

## 6.9 Codepad fire alarm

An audible codepad Fire Alarm activates when a user presses [4] and [6] on the remote codepad simultaneously. A distinct fire sound emits through the horn speaker to indicate this type of alarm. The fire sound is different than the burglary sound.

Select Option 2 in Location 493 to program the codepad Fire Alarm as silent (refer to *System Options 2, page 135*). A codepad Fire Alarm transmits a Contact ID Event Code 110 to a base station receiver.

## 6.10 Codepad medical alarm

An audible codepad Medical Alarm activates when a user presses [7] and [9] simultaneously. Select Option 4 in Location 493 to program codepad Medical Alarm as silent (refer to *System Options 2, page 135*). A codepad Medical Alarm transmits a Contact ID Event Code 100 to a base station receiver.

## 6.11 Isolating zones

Isolating zones allows you to manually disable one or more zones before arming the system in AWAY Mode, STAY Mode 1, or STAY Mode 2. When a zone is isolated, access is allowed into that zone when the system is armed without activating an alarm.

For example, you might want to isolate a zone before arming the system because a zone passive infrared (PIR) detector is activating false alarms or because you need to leave a pet inside a particular zone while you are away.

You can isolate zones using one of two methods. By default, the standard isolation method is used. Standard isolation does not require a User Code. The other method requires a valid User Code. The ability to isolate zones is determined by the priority level assigned to each User Code holder. Some User Code holders cannot isolate zones. Refer to *User Code Priority, page 86* for more information.

Zones that are manually isolated using this method transmit a Zone Bypass Report (Contact ID Event Code 573) for each isolated zone when the system is armed. A Zone Bypass Restore Report is transmitted when the system is disarmed.

When you select a 24-Hour Fire Zone to be isolated, a Contact ID Event Code 571 is sent. If you select another 24-Hour Zone to be isolated, a Contact ID Event Code 572 is sent. A Zone Bypass Report is transmitted once the 24-Hour Zone is isolated. A Zone Bypass Restore Report is transmitted when the system is disarmed or the isolated zone is restored.

You can isolate zones manually using these two methods, and you can also isolate zones automatically as programmed by the installer.

How to isolate zones automatically in STAY Mode 1, refer to *Zone Options 2, page 98*.

How to isolate zones automatically in STAY Mode 2, refer to *STAY Mode 2 Automatically Bypass Zones, page 102*.

### 6.11.1 Standard isolating

Standard isolating allows any operator to isolate zones because no code is required.

1. Press [STAY] twice. Three beeps sound and the STAY indicator flashes.
2. Enter the number of the zone to be isolated and press [STAY]. The indicator for the zone flashes. 24-Hour zones are automatically isolated as soon as you press [STAY]. All other Burglary Zones are automatically isolated only after the system is armed.

3. Repeat *Step2* for each zone you want to isolate.

**Notice!**

As each zone is selected to be isolated, the corresponding zone indicator flashes. If you make a mistake, enter the incorrect zone number and press [STAY]. This zone is no longer selected to be isolated and the zone indicator is extinguished.

4. Press [AWAY].  
Two beeps sound and the system returns to the disarmed state.  
The indicators for the selected zones continue to flash until the next time the system is disarmed.

**Example:**

To manually isolate zones 1, 3, and 4, press: [STAY][STAY][1][STAY][3][STAY][4][STAY][AWAY]

### 6.11.2

**Code to isolate**

The code to isolate method permits only those User Code holders with a priority level that includes Code to Isolate. The standard isolating method is disabled for any User Code with this priority level set.

1. Press [STAY].
2. Enter your code and press [STAY]. Three beeps sound and the STAY indicator flashes. If you attempt to enter isolating mode with a User Code that is not set for Code to Isolate, the system ignores the attempt.
3. Enter the number of the zone to be isolated and press [STAY]. The indicator for the zone flashes. 24-Hour zones are automatically isolated as soon you press [STAY]. All other Burglary zones are automatically isolated only after the system is armed.
4. Repeat *Step3* for each zone you want to isolate.

**Notice!**

As each zone is selected to be isolated, the corresponding zone indicator flashes. If you make a mistake, enter the incorrect zone number and press [STAY]. This zone is no longer selected to be isolated and the zone indicator is extinguished.

5. Press [AWAY].  
Two beeps sound and the system returns to the disarmed state.  
The indicators for the selected zones continue to flash until the next time the system is disarmed.

**Example**

To manually isolate zones 1, 3, and 4, press: [STAY][User Code][STAY][1][STAY][3][STAY][4][STAY][AWAY]

## 6.12

**Fault analysis mode**

When a system fault occurs, the FAULT or MAINS indicator flashes and the codepad beeps once per minute.

If the AC MAINS supply fails, the MAINS indicator flashes until the AC MAINS supply is restored. Press [AWAY] once to acknowledge the fault and stop the codepad from beeping once every minute.

**To enter Fault Analysis Mode to determine a system fault other than the AC MAINS supply:**

1. Press and hold [5] until two beeps sound. The FAULT indicator remains lit and the STAY and AWAY indicators flash. The lit zone indicators indicate the type of fault that occurred.
2. If necessary, press the button corresponding to the indicator to further determine the fault. (Refer to the table Fault Analysis Conditions below.)
3. To exit from Fault Analysis Mode, press [AWAY]. The STAY and AWAY indicators are extinguished and the FAULT indicator remains lit.

**Fault Indicators**

Zone Indicator	Fault Description	Press Button	Zone Indicator	Fault Condition
1	System Fault	1	1 2 3 4 5 7 8 9 to 16	Battery Fail Date and Time RF Receiver Fail Output 1 to 3 Fail Telephone Line Fail Power Supply Fail Onboard Tamper RF Repeaters 1 to 8 Fail (Solution 2000 N.A.)
2	RF Low Battery (Solution 2000 N.A.)	2	1 to 16	Zones 1 to 16 RF Low Battery
3	Zone Tamper Alarm	3	1 to 16	Zones 1 to 16 Tamper Alarm
4	Sensor Watch Fault	4	1 to 16	Zones 1 to 16 Sensor Watch Fail
5	RF Sensor Missing (Solution 2000 N.A.)	5	1 to 16	Zones 1 to 16 RF Sensor Watch Fail
6	Communication Fail	6	1 2 3 4	Receiver 1 Fail Receiver 2 Fail IP Module 1 Fail IP Module 2 Fail
7	Output and Codepad Fail	7	1 to 2 3 to 6	Output Expanders 1 to 2 Fail Codepads 1 to 4 Fail
8	Keyfob Low Battery	8	1 to 16	Keyfobs 1 to 16 Low Battery

**Table 6.1: Fault Indicators**

When working with a text codepad, press [5] to enter [Fault Analysis], you can page up or page down to view the fault items, and press [AWAY] to exit from Fault Analysis Mode.

## 6.13

### Fault descriptions

#### 1 – System Fault

The system FAULT indicator lights when any of the faults listed in the table System FAULT Indicators below occurs. In Fault Analysis Mode, press [1] to determine the fault that occurred.

**2 – RF Device Low Battery**

This fault occurs when any of the RF wireless devices report a low battery condition to the control panel. While in Fault Analysis Mode, press the [2] key until two beeps sound. This displays the zone reporting the RF Low Battery fault.

**3 – Zone Tamper Fail**

This fault occurs when any zone with tamper becomes an open or short circuit. Press the [3] key until two beeps sound. This displays the zone reporting the tamper fail fault.

**4 – Sensor Watch Fault**

A sensor watch fault registers when one or more detection devices failed to detect any movement during the disarmed state for the time programmed in Locations 476 and 477 (refer to *Sensor Watch Report*, page 111). The fault clears once the zone in question detects movement and resets. Press the [4] key until two beeps sound. This displays the zone reporting the sensor watch fault.

**5 – RF Sensor Missing**

An RF sensor missing registers when one or more RF detection devices fails to communicate to the RF radio receiver for the time period programmed in Location 393 RF Supervision Time. The fault clears once the RF device in question successfully transmits to the RF radio receiver. While in Fault Analysis Mode, press the [5] key. This displays the RF detection device reporting the RF sensor watch fault.

**6 – Communication Fail**

A communication fail registers when the control panel fails to communicate with the receiving party (such as a monitoring company, mobile phone). The communication fault clears once the control panel successfully reports to the receiving party.

A communication fail also registers when network module is disconnected or tampered.

To determine which receiver or module failed to communicate, press the [6] key.

In Fault Analysis Mode, press [6] to show which communication fault occurred: 1 – Receiver 1; 2 – Receiver 2.

**7 – Output and Codepad Fail**

The output fault registers when any output expander B308 is disconnected or tampered.

The codepad fault registers when any codepad is tampered or disconnected from the control panel.

To determine which fault occurred, press the [7] key.

**8 – Keyfob Low Battery**

This fault occurs when any of the RF keyfobs report a low battery condition to the control panel. To determine which keyfob failed, press the [8] key. Only keyfob 1 to 16 faults display on the codepad through zone indicator 1 to 16.

**System FAULT indicators**

Indicator	FAULT description
1	<b>Low battery</b> This fault registers when the system detects a low capacity backup battery. The system automatically performs a battery test every 4 hours and every time you arm the system.
2	<b>Date and time</b> This fault registers when the system is powered down.

Indicator	FAULT description
3	<b>RF receiver fault</b> This fault registers when the RF wireless receiver unit detects RF jamming, the RF wireless receiver is disconnected from the control panel or failed, or the RF receiver's cover tamper switch is activated.
4	<b>Warning Device fault</b> This fault registers when the system detects output 1-3 as warning device (Horn Speaker, Siren Running, Strobe) is disconnected or short. This fault clears once all outputs are reconnected. This feature is enabled by selecting Option 2 in Location 492 (refer to <i>System Options 1, page 134</i> ).
5	<b>Telephone line fault</b> This fault registers when the system detects the telephone line is disconnected from the control panel. This feature is enabled by selecting Option 1 in Location 176.
7	<b>Power Supply fail</b> This fault occurs when AUX power supplies fail, +12V power fails, or SDI2 Bus power fails. Contact your installer as soon as this fault displays.
8	<b>Onboard Tamper</b> This fault occurs when the system detects the control panel is tampered.
9-16	<b>RF Repeater Tamper/Fail</b> The RF repeater 1 to 8 fault registers once the system detects that the wireless repeater is disconnected or the repeater tamper is triggered.

### AC MAINS Failure

An AC MAINS supply failure automatically flashes the MAINS indicator. If the AC MAINS supply is disconnected continuously for longer than 2 min, the remote codepad beeps the codepad buzzer once per min. If the control panel is programmed to report an AC MAINS failure to a base station receiver, an AC Fail Report (Contact ID Event Code 301) is transmitted.

The MAINS indicator stops flashing when the AC MAINS supply is reconnected. When the AC MAINS supply is connected continuously for 2 min, the codepad stops the once per min beep and an AC Fail Restore Report is transmitted to the base station receiver.

If the Enable AC Fail in 1 Hour option (1) is selected in Location 494 (refer to *System Options 3, page 135*), the codepad flashes the MAINS indicator when the AC MAINS supply is disconnected, but does not activate the report or the codepad buzzer unless the AC MAINS supply is disconnected continuously for 1 hour.

If the Ignore AC MAINS Fail option (2) is selected in Location 494 (refer to *System Options 3, page 135*) the codepad does not indicate when the AC MAINS supply fails, but the control panel still reports an AC Fail Report, if enabled.

## 7 System Functions

This section explains more advanced features, such as Installer Code, Master Code, and hold-down functions that are required for testing and regular maintenance of the system.

Operations described in this chapter are based on use with the IUI-SOL-ICON codepad. For the IUI-SOL-TEXT codepad, follow the prompts on the codepad display.

### 7.1 Installer Code Functions

Installer Code functions allow the installer to perform various system tests and tasks without knowing a Master Code.

To access the required Installer Code function, enter the Installer Code and corresponding function digit, and press [AWAY]. The Installer Code functions are listed in the table Installer Code Functions below. You can access these functions only when the system is disarmed.

#### Installer Code Functions

Function	Description
0	Add/delete RF wireless devices / keyfobs / repeaters
1	Set the number of days until the first Test Report
2	Change domestic telephone numbers
3	Change the Telco arm/disarm sequence
4	Set bypass zones for STAY Mode 2
6	Turn report monitor mode on and off
7	Walk test mode
8	Event memory recall mode

#### 7.1.1 Add or Delete RF Wireless Devices



##### Notice!

The Solution 2000 control panel does not support wireless devices.

The Solution 3000 control panel can accept up to 16 wireless devices on the system. It is possible to enroll wireless PIRs, reed switches, and smoke detectors to the control panel. This control panel supports the following RF sensors:

- RFDW-SM
- RFDW-RM
- RFUN
- RFPR-12
- RFPR-C12
- RFDL-11
- RFGB
- RFBT
- RFSM

You can allocate only one wireless device to each zone.

**To program an RF wireless device:**

1. Use the installer code to configure the RF receiver as RADION receiver (address = 395). Save the changes and Exit programming mode.
2. Enter the Installer Code and press [0][AWAY]. Two beeps sound and the STAY and AWAY indicators flash.
3. Enter the RF device number (1 to 16) you want to change and press [AWAY]. Two beeps sound and the corresponding codepad indicator lights to show the RF device number you selected.
4. There are two ways to enter the RFID:
  - Enter the nine-digit RFID number found on the back of the RF device and press [AWAY]. Two beeps sound. The control panel will sound one error beep and exit if the wrong check-sum or a duplicated RFID number is entered.
  - Press [STAY] to switch into auto-learn mode. Note that all the codepad indicators (1~16) flash on the icon codepad. Trigger the wireless device. The control panel will sound 3 beeps and learn the RFID. The last digit of the RFID number is displayed on the codepad. Press [AWAY] to confirm. If the zone has already been used in the system, the panel will ignore this RFID.
5. Press [AWAY] to accept the default value for the zone input option, or enter a different zone input option value (0~15) and press [AWAY] to finish this function and reset the control panel.
6. The user can press [STAY] to cancel the wireless zone enrollment at any step except during the delete process. The codepad sounds one error beep, cancels the enrollment, and exits.

**Example:**

To add RF wireless device number 3 whose 9- digit ID number is 000094946, enter [1 2 3 4 0] [AWAY][3][AWAY] [0 0 0 0 9 4 9 4 6][AWAY][AWAY].

**To delete an RF wireless device:**

1. Enter the Installer Code and press [0][AWAY]. Two beeps sound and the STAY and AWAY indicators flash.
2. Enter the RF device number (1 to 16) you want to delete and press [AWAY]. Two beeps sound and the corresponding codepad indicators light to show the RF device number you selected.
3. Press [STAY] to delete the RF device. The STAY and AWAY indicators are extinguished.
4. Repeat steps 1 to 3 to delete another RF wireless device.

**7.1.2****Add/Delete RF Repeater****Notice!**

The Solution 2000 control panel does not support RF repeaters.

**Add RF Repeater**

Set RF receiver as RADION Receiver.

1. Enter the Installer Code, followed by [0] and the [#] key (for example, [12340#]).
2. Enter the point ID of RADION Repeater (822 to 829) you want to add (822 = 1,823 = 2, etc.), followed by the [#] key. Repeater number (1 to 8) displays on the ICON codepad.
3. Use manual mode or auto-learn mode to configure Repeater RFID.
  - In manual mode, enter the 9-digit RF Repeater ID number, followed by the [#] key.



- Or press [\*] key to switch into auto-learn mode. When icon numbers (1 to 16) flash, tamper the RF Repeater. The panel learns the RF Repeater ID number and the last digit of RFID number displays on the codepad. Press [#] key to confirm.
4. Enter [#] key to confirm the operation, or enter [\*] to cancel.

#### **Delete RF Repeater**

1. Enter the Installer Code, followed by [0] and the [#] key.
2. Enter the point id of RADION Repeater (822 to 829) you want to delete, followed by the [#] key.
3. Press the [\*] key to delete the RF Repeater.

#### **Example:**

To delete existing RF Repeater 8: Enter your installer code and press [0] [#] [8] [2] [9] [#] [\*].

### 7.1.3

## **Add/Delete RF Keyfob**

### **Add WE800EV2 Keyfob**



#### **Notice!**

Learn all WE800EV2 keyfobs via WE800EV2 receiver Learn/Delete button before adding the WE800EV2 keyfobs to the system. Refer WE800EV2 manual for learn/delete fobs.

Set RF receiver as WE800EV2 Receiver.

1. Enter the Installer Code, followed by [0] and the [#] key (for example, [12340#]).
2. Enter the WE800EV2 keyfob number (301 to 332) you want to add (301 = keyfob 1, 302 = keyfob2, etc.), followed by the [#] key. Up to 21 WE800EV2 keyfobs can be added, but only current keyfob number (1 to 16 ) displays through zone indicators on the ICON codepad.
3. Only use auto-learn mode to configure keyfob RFID. Press [\*] key to switch into auto-learn mode. When icon numbers (1 to 16) flash, press button 1 or 2 of the keyfob. The panel learns the WE800EV2 Keyfob ID number and the last digit of RFID number displays on the codepad. Press [#] key to confirm.
4. Enter [#] key to confirm the operation, or press [\*] to cancel.

#### **Delete WE800EV2 Keyfob**

1. Enter the Installer Code, followed by [0] and the [#] key.
2. Enter the WE800EV2 keyfob number (301 to 332) you want to delete, followed by the [#] key.
3. Press the [\*] key to delete the WE800EV2 Keyfob.

#### **Add RADION Keyfob**

Set RF receiver as RADION Receiver.

1. Enter the Installer Code, followed by [0] and the [#] key (for example, [12340#]).
2. Enter the RADION keyfob number (301 to 332) you want to add (301 = keyfob 1, 302 = keyfob2, etc.), followed by the [#] key. Up to 32 RADION keyfobs can be added, but only current keyfob number (1 to 16 ) displays through zone indicators on the ICON codepad.
3. Use manual mode or auto-learn mode to configure RADION keyfob RFID.
  - In manual mode, enter the 9-digit RF device ID number, followed by the [#] key.
  - Or press [\*] key to switch into auto-learn mode. When icon numbers (1 to 16) flash, press button 1 or 2 of the keyfob. The panel learns the RADION Keyfob ID number and the last digit of RFID number displays on the codepad. Press [#] key to confirm.
4. Enter [#] key to confirm the operation, or press [\*] to cancel.

#### **Delete RADION Keyfob**

1. Enter the Installer Code, followed by [0] and the [#] key.

2. Enter the RADION keyfob number (301 to 332) you want to delete, followed by the [#] key.
3. Press the [\*] key to delete the RADION Keyfob.

**Example:**

To delete existing RADION keyfob 1: Enter your installer code and press [0] [#] [3] [0] [1] [#] [\*].

**Notice!**

The Solution 2000 control panel does not support RADION keyfobs.

**7.1.4****Set the Number of Days until the First Test Report**

This function determines when the system sends the first Test Report (Contact ID Event Code 602). If you do not use this Installer Code function, the first Test Report is sent to the base station receiver after the repeat interval programmed in Location 434 (refer to *Test Reporting Time, page 109*). If you want the system to send the first Test Report sooner than the repeat interval, use this function to set when the first Test Report is sent.

**To set the first Test Report:**

1. Enter the Installer Code and press [1][AWAY]. Three beeps sound and the STAY and AWAY indicators flash.
2. Enter the number of days (1 to 15) and press [AWAY]. Two beeps sound and the STAY and AWAY indicators are extinguished. The system returns to the disarmed state.

**7.1.5****Change Domestic Phone Numbers**

When the system is set up for domestic dialing, this function allows the installer to view and program the telephone numbers the system calls if an alarm occurs. Refer to *Domestic Dialing, page 76* for more information.

**To change domestic phone numbers:**

1. Enter your passcode and press [2][AWAY]. Three beeps sound and the STAY and AWAY indicators flash. There are 4 telephone number locations. Numbers 1 and 2 are for receiver 1. Numbers 3 and 4 are for receiver 2.
2. Press the sequence number to view and set/modify the corresponding telephone number.
  - If telephone numbers are programmed, they are displayed one digit at a time using the remote codepad indicators. Refer to the table Domestic Dialing Digits below for the indicators and their meanings.
  - If no telephone numbers are programmed, [15] is displayed and an additional two beeps sound after entering this mode. These two beeps normally sound after you enter the last digit of the last phone number.
3. Enter the digits for the phone number. Each digit is displayed as you enter it.
4. Press the [AWAY] to save and exit from this mode.
5. Repeat steps 1 - 4 to program another phone number.

Digit Required	Number to Program	Digit Required	Number to Program
0	0	8	8
1	1	9	9
2	2		

Digit Required	Number to Program	Digit Required	Number to Program
3	3	*	* 1
4	4	#	* 2
5	5	4-sec Pause	* 3
6	6		
7	7	Terminator	* 5

**Table 7.1: Domestic Dialing Telephone Digits**

**Example:**

To program telephone numbers (96721777-primary and 96721233-backup) for receiver 1, enter the following sequence:

[1234 2][AWAY][1][AWAY][9 6 7 2 1 7 7 7][AWAY][2 5 8 0 2][AWAY][2][AWAY] [4 9 6 7 21 2 3 3][AWAY]

You can cancel domestic dialing at any time (for example, you are moving and do not want the system to continue calling your work place or mobile phone).

**To disable domestic dialing:**

Enter your Master Code and press [2][AWAY] [1][STAY][5][AWAY]. Once the primary number is disabled, the secondary number will be unavailable also.

## 7.1.6

### Change Telco Arm/Disarm Sequence

This feature allows you to program the telco arm sequence and telco disarm sequence. This feature is available only if your telecommunication provider has the call forward option available. Refer to *Telco Arming Sequence, page 70* and *Telco Disarming Sequence, page 71* for more information.

**Telco Arm Sequence**

This allows you to program the Call Forward – Immediate On sequence or Call Forward – No Answer sequence that automatically operates when you arm the system in the AWAY Mode.



**Notice!**

The examples provided for this feature apply only to Australia.

– **Call Forward – Immediate On**

You can redirect calls to anywhere in Australia, including mobiles and answering services. When this Call Forward option is turned on, the telephone to which the control panel is connected does not ring.

– **Call Forward – No Answer**

If your telephone is not answered within 20 sec, this feature redirects the incoming call to another number anywhere in Australia. You can still make outgoing calls.

**Telco Disarming Sequence**

This option allows you to automatically disable the call forward sequence when you disarm the system.

Digit Required	Number to Program	Digit Required	Number to Program
0	0	8	8
1	1	9	9

Digit Required	Number to Program	Digit Required	Number to Program
2	2		
3	3	*	* 1
4	4	#	* 2
5	5	4-sec Pause	* 3
6	6		
7	7	Terminator	* 5

**Table 7.2: Dialing Digits**

**To program the telco arming sequence:**

1. Enter your passcode and press [3][AWAY]. Three beeps sound and the STAY and AWAY indicators flash.
2. Press [1][AWAY] to change the telco arming sequence. Three beeps sound.
  - If a call forward sequence is already programmed, the sequence is displayed one digit at a time using the codepad indicators. Refer to the table Telco Arm/Disarm Digits above for the indicators and their meanings.
  - If no call forward sequence is programmed, an additional two beeps sound after entering this mode. These two beeps normally sound after the last digit of the call forward sequence is displayed.
3. Enter the desired call forward sequence. For example, program [\* 6 1][phone number][#] for the call forward – no answer sequence, or [\* 2 1][phone number][#] for the call forward – immediate sequence.



**Notice!**

When you program a \* in the telco arm sequence, enter [STAY][1]. When you program the # in the telco arm sequence, enter [STAY][2].

4. Press [STAY][2][AWAY]. Two beeps sound and the system returns to the disarmed state.

**Example**

If you want to automatically divert all unanswered incoming calls to another telephone number (for example, 9672 1777) when the system is armed in AWAY Mode, enter:

```
[1234 3][AWAY][1][AWAY][STAY]
[1 6 1 9 6 7 2 1 7 7 7][STAY][2][AWAY]
```

You can suspend the telco arming sequence at any time. **To disable the telco arming sequence:**

Enter your passcode and press [3][AWAY][1] [AWAY][STAY][5][AWAY].

**To program the telco disarming sequence:**

1. Enter your passcode and press [3][AWAY]. Three beeps sound and the STAY and AWAY indicators flash.
2. Press [2][AWAY] to change the telco disarming sequence. Three beeps sound.
  - If a telco disarming sequence is already programmed, the sequence is displayed one digit at a time using the codepad indicators. Refer to the Telco Arm/Disarm Dialing Digits table above for the indicators and their meanings.
  - If no telco disarming sequence is programmed, an additional two beeps sound after entering this mode. These two beeps normally sound after the last digit of the sequence is displayed.

3. Enter the desired call forward disable sequence. For example, program [# 6 1 #] to disable the call forward – no answer sequence, or [# 2 1 #] to disable the call forward – immediate sequence.
4. Press [AWAY]. Two beeps sound and the system returns to the disarmed state.

You can suspend the telco disarming sequence at any time. **To disable the telco disarming sequence:**

Enter your Installer Code and press [3][AWAY][2] [AWAY][STAY][5][AWAY].

### 7.1.7

#### Setting STAY Mode 2 Bypass Zones

This function allows the installer to select the zones that are automatically isolated when the system is armed in STAY Mode 2.

To arm the system in STAY Mode 2, press and hold [0] until two beeps sound. Refer to *Arming the system from STAY Mode 2*, page 32 for more information.

##### To set STAY Mode 2 zones:

1. Enter the passcode and press [4][AWAY]. Three beeps sound and the STAY indicator flashes.
2. Enter the number of the zone you want to automatically isolate and press [STAY]. The corresponding zone indicator flashes.
3. Repeat step 2 for each zone you want to select.



##### Notice!

As each zone is selected to be isolated, the corresponding zone indicator flashes. If you make a mistake, enter the incorrect zone number and press [STAY]. This zone is no longer selected to be isolated and the zone indicator is extinguished.

This function does not work on a partitioned control panel system.

4. Press [AWAY]. Two beeps sound and the system returns to the disarmed state. The indicators for the zones you selected and the STAY indicator are extinguished.

##### Example

If you want to select zones 2, 5, and 6, enter:

[1 2 3 4 4][AWAY][2][STAY][5][STAY][6][STAY] [AWAY]

You can disable selected zones to be automatically isolated for STAY Mode 2 at any time.

To disable STAY Mode 2 zones:

Enter your passcode and press [4][AWAY] [AWAY].

### 7.1.8

#### Turning Report Monitor Mode On and Off

Report Monitor Mode allows you to use the codepad for visual representation of data transmissions between the control panel and the base station receiver. The transmission sequence is also shown in this mode.

The codepad beeps once every two sec when Report Monitor Mode is active, whether the system is in Installer's Programming Mode or normal operating mode. The first five indicators on the ICON codepad show the progressive steps during a transmission to the base station receiver for Receiver 1, Indicator 9-13 for Receiver 2 .

After you activate Report Monitor Mode, hold down [9] until two beeps sound to initiate a Test Report.

##### Report Monitor Mode Indications

Zone indicator	Dialing event
1, 9	Telephone line seized
2, 10	Dialing phone number / Network connect
3, 11	Handshake received
4, 12	Data is being transmitted
5, 13	Kiss-off received
None	Telephone line / Network released / idle

Zone Indicator 1-5 for Receiver1, Zone Indicator 9-13 for Receiver 2.

**To turn Report Monitor Mode on:**

1. Enter the Installer Code and press [6][AWAY]. Three beeps sound.
2. Press and hold [9] until two beeps sound. A Test Report is sent.

**To turn Report Monitor Mode off:**

Enter the Installer Code and press [6][AWAY]. Two beeps sound.



**Notice!**

You must exit from Report Monitor Mode to resume normal operations.

## 7.1.9

### Walk Test Mode

Walk Test Mode allows you to test detection devices to ensure they are functioning correctly. Before activating Walk Test Mode, isolate any zones that are not required for testing. Refer to *Isolating zones, page 34* for more information.

**To enter Walk Test Mode:**

1. Enter the passcode and press [7][AWAY]. Three beeps sound and the STAY and AWAY indicators flash. The codepad beeps once per sec when Walk Test Mode is active.
2. Unseal and seal the zones to be tested. The codepad sounds one long beep and the horn speaker sounds one short beep each time a zone is sealed or unsealed.
3. Press [AWAY] to exit from this function. Two beeps sound and the STAY and AWAY indicators are extinguished. The system returns to the disarmed state.

## 7.1.10

### Event Memory Recall Mode

This function allows you to play back the last 256 system events that occurred. Event Memory Recall Mode reports all alarms and each arming or disarming of the system, on Text LCD Codepad, it can also help with troubleshooting system faults. The events are displayed using the codepad indicators.

**To enter Event Memory Recall Mode:**

Enter the Installer Code and press [8][AWAY]. Three beeps sound. The events are played back by the codepad indicators in reverse chronological order.





**Example**

If the events occurred in the following order:

Sequence	Event
1	System armed in AWAY Mode
2	Alarm in Zone 3

Sequence	Event
3	Alarm in Zone 4
4	System disarmed
5	System armed in STAY Mode

The alarm memory plays back in this order:

Sequence	Indicator On	Event
1	 2	Stay armed by User 2
2	 1	Disarmed by User 1
3	 4	Alarm in Zone 4
4	 3	Alarm in Zone 3
5	 2	AWAY armed by User 2

Each event is indicated by a beep every 2 second and a lit indicator. You can also press [STAY] key to review the previous event.

After the last event, three beeps sound to indicate the end of playback. You can stop the replay at any time by pressing [AWAY].

When working with a text codepad, the events are played back automatically after entered event memory recall mode. And you can also page up or page down manually to review the events. You can stop the replay at any time by pressing [AWAY].



#### Notice!

If the system is armed in STAY Mode 1 or STAY Mode 2, the STAY indicator shows the event memory playback. There is no differentiation between STAY Mode 1 and STAY Mode 2.

If the control panel is powered down, the memory of all events is saved.

## 7.2

### Master Code Functions

Master Code functions allow those users that have the appropriate priority level to perform certain supervisory level functions. You can use these functions only when the system is disarmed.



#### Notice!

The default Master Code (User Code 1) is 2580. It is possible to program multiple Master Codes. Refer to *User Code Priority*, page 86 for more information.

To access a Master Code function, enter the Master Code and press the corresponding function digit and the [AWAY] button. Except the Master Code functions listed in the table below, Master Code functions also allows the users to arm or disarm single area.

Function	Description
0	Arm or disarm both areas at the same time
1	Add, change and delete user codes / remote radio user codes (RF keyfobs)
2	Change domestic phone numbers
3	Change Telco arm/disarm sequence
4	Set bypass zones for STAY Mode 2
5	Turn outputs on and off
6	Set the date and time
7	Walk test mode
8	Event memory recall mode
9989	System reset

**Table 7.3: Master Code Functions**

## 7.2.1

### Arm or Disarm both Areas at the Same Time

This Master Code function only operates with partitioned control panel systems and allows Master Codes allocated to both Area 1 and Area 2 to arm or disarm both areas at the same time.

This feature allows a Master Code holder to arm or disarm the system by pressing one extra button rather than entering a code twice. You can use any area codepad by a User Code assigned to both areas with this function. To enable this feature, select Option 2 in Location 501 (refer to *Partitioning Options 2*, page 140).

#### To arm or disarm both areas at the same time:

Enter your Master Code and press [0][AWAY]. Two beeps sound and both areas are armed or disarmed from AWAY Mode.

## 7.2.2

### Arm or Disarm Single Area

This Master Code function allows to arm or disarm single area with any codepad.

#### How to arm Area 1 or Area 2 in AWAY Mode

Enter your user code followed by [0][1] and the [#] button ( for example, [258001#]) to arm Area 1; or enter your user code followed by [0][2] and the [#] button ( for example, [258002#]) to arm Area 2. Two beeps sound and the AWAY indicator displays. Exit Time starts counting.

#### How to disarm Area 1 or Area 2 in AWAY Mode

Enter your user code followed by [0][1] and the [#] button ( for example, [258001#]) to disarm Area 1; or enter your user code followed by [0][2] and the [#] button ( for example, [258002#]) to disarm Area 2. Two beeps sound and the AWAY indicator extinguishes.

#### How to arm Area 1 or Area 2 in STAY Mode 1

Enter your user code followed by [0][1] and the [\*] button ( for example, [258001\*]) to arm Area 1; or enter your user code followed by [0][2] and the [\*] button ( for example, [258002\*]) to arm Area 2. Two beeps sound and the STAY indicator displays. Exit Time starts counting.



### How to disarm Area 1 or Area 2 in STAY Mode 1

Enter your user code followed by [0][1] and the [\*] button ( for example, [258001\*]) to disarm Area 1; or enter your user code followed by [0][2] and the [\*] button ( for example, [258002\*]) to disarm Area 2. Two beeps sound and the STAY indicator extinguishes.

## 7.2.3

### Changing and Deleting User Codes

This function allows a Master Code holder to change or delete a User Code.

When using a partitioned Control Panel, the Master Code holder cannot add, change, or delete User Codes unless the User Code is allocated to the same area as the Master Code. Refer to *User Code Priority, page 86* for more information.

#### To change a User Code:

1. Enter your Master Code and press [1][AWAY]. Three beeps sound and the STAY and AWAY indicators flash.
2. Enter the number of the code (1 to 32) you want to change and press [AWAY]. Two beeps sound and the corresponding zone indicator lights.
3. Enter the new code and press [AWAY]. Two beeps sound and the STAY and AWAY indicators are extinguished.
4. Repeat this procedure to change other User Codes.



#### Notice!

One long beep indicates that the code already exists or you entered an incorrect user number.

#### Example

To program User Code number 2 as 4627, enter: [2 5 8 0 1][AWAY][2][AWAY][4 6 2 7][AWAY]

#### To delete a User Code:

1. Enter your Master Code and press [1][AWAY]. Three beeps sound and the STAY and AWAY indicators flash.
2. Enter the number of the code (1 to 32) you want to delete and press [AWAY]. Two beeps sound and the corresponding zone indicator lights.
3. Press [STAY] to delete the User Code. Two beeps sound and the STAY and AWAY indicators are extinguished.
4. Repeat this procedure to delete other User Codes.

#### Example

To delete User Code number 3, enter: [2 5 8 0 1][AWAY][3][AWAY][STAY]

## 7.2.4

### Adding Remote Radio User Codes

This function allows a Master Code holder to add a remote radio User Code ( RF keyfob).

#### To Add a WE800EV2 Keyfob

Set RF receiver as WE800EV2 Receiver. Confirm that the keyfob has been added to the WE800EV2 receiver. Refer to *WE800EV2 receiver, page 17 – Add/delete keyfobs*.

1. Enter your Master Code, followed by [1] and the [#] button (for example, [25801#]).
2. Enter the WE800EV2 keyfob number (301 to 332) you want to add, followed by the [#] button. Up to 21 WE800EV2 keyfobs can be added, but only current keyfob number (1 to 16 ) displays through zone indicators on the ICON codepad.

3. Only use auto-learn mode to configure keyfob RFID. Press [\*] button to switch into auto-learn mode. When icon numbers (1 to 16) flash, press button 1 or 2 of the keyfob. The control panel learns the WE800EV2 keyfob ID number and the last digit of RFID number displays on the codepad. Press [#] button to confirm.
4. Enter [#] button to confirm the operation, or press [\*] to cancel.

#### **To Add a RADION keyfob**

Set RF receiver as RADION Receiver.

1. Enter your Master Code, followed by [1] and the [#] button (for example, [25801#]).
2. Enter the RADION keyfob number (301 to 332) you want to add, followed by the [#] button. Up to 32 RADION keyfobs can be added, but only current keyfob number (1 to 16 ) displays through zone indicators on the ICON codepad.
3. Use manual mode or auto-learn mode to configure the RADION keyfob RFID.
  - In manual mode, enter the 9-digit RF device ID number followed by [#], or press [\*] to switch into auto-learn mode. When icon numbers (1 to 16) flash, press the 1 or 2 button on the keyfob. The control panel learns the RADION keyfob ID number and the last digit of RFID number displays on the codepad. Press [#] to confirm.
4. Press [#] to confirm the operation, or press [\*] to cancel.

## **7.2.5**

### **Deleting User/Radio Codes**

Only the Master Code holder can delete other system user codes.

#### **To Delete a User Code**

1. Enter your Master Code, followed by [1] and the [#] button (for example, [25801#]). Three beeps sound and the STAY and AWAY indicators flash.
2. Enter the user code number (1 to 32), followed by the [#] button (for example, [2#] = User 2, [16#] = User 16). Two beeps sound and the selected user number displays on the codepad indicators.
3. Press the [\*] button to delete the selected User Code. Two beeps are heard and the STAY and AWAY indicators turn off.
4. To delete other User Codes, repeat this procedure as many times as required.

#### **To Delete a WE800EV2 Keyfob**

1. Enter your Master Code, followed by [1] and the [#] button.
2. Enter the WE800EV2 keyfob number (301 to 332) you want to delete, followed by the [#] button.
3. Press the [\*] button to delete the WE800EV2 Keyfob.

#### **To Delete a RADION Keyfob**

1. Enter your Master Code, followed by [1] and the [#] button.
2. Enter the RADION keyfob number (301 to 332) you want to delete, followed by the [#] button.
3. Press the [\*] button to delete the RADION Keyfob.

## **7.2.6**

### **Change Domestic Phone Numbers**

#### **See also**

- *Change Domestic Phone Numbers, page 42*

## 7.2.7 Change Telco Arm/Disarm Sequence

### See also

- *Change Telco Arm/Disarm Sequence, page 43*

## 7.2.8 Setting STAY Mode 2 Bypass Zone

### See also

- *Setting STAY Mode 2 Bypass Zones, page 45*

## 7.2.9 Turning Outputs On and Off

If an output is programmed for remote operation, you can turn the remote output on or off using this Master Code function or remotely using the A-Link Software or smartphone application (RSC).

To use this Master Code function, you must program one or more of the outputs with these Output Event Types, refer to *Output Event Types, page 120*.

Remote control output 1 = Output Event Type 2,8

Remote control output 2 = Output Event Type 2,9

Remote control output 3 = Output Event Type 2,10

Remote control output 4 = Output Event Type 6,2

Remote control output 5 = Output Event Type 6,3

.....

Remote control output 20 = Output Event Type 7,2

### To turn an output on from the codepad:

1. Enter your Master Code and press [5][AWAY]. Three beeps sound and the STAY and AWAY indicators flash.
2. Enter the number of the output (1 to 20) and press [AWAY]. Three beeps sound and the output turns on.
3. Repeat *Step2* to turn on another output.
4. Press [AWAY] to exit from this function. Two beeps sound and the STAY and AWAY indicators are extinguished.

### Example

If Output 2 is programmed as 2,9,1,0,0,0 in Locations 442 to 447, the Master Code holder can turn on this output by entering:

```
[2 5 8 0 5][AWAY][2][AWAY][AWAY]
```

### To turn an output off from the remote codepad:

1. Enter your Master Code and press [5][AWAY]. Three beeps sound and the STAY and AWAY indicators flash.
2. Enter the number of the output (1 to 20) and press [STAY]. Two beeps sound and the output turns off.
3. Repeat *Step2* to turn off another output.
4. Press [AWAY] button to exit from this function. Two beeps sound and the STAY and AWAY indicators are extinguished.

### Example

If Output 2 is programmed as 2,9,1,0,0,0 in Locations 442 to 447, the Master Code holder can turn off this output by entering:

```
[2 5 8 0 5][AWAY][2][STAY][AWAY]
```

### 7.2.10 Setting the Date and Time

Use this function when the date and time must be changed or if the system was powered down.

If the date and time is not set, the date and time fault appears only when the Auto Arming Time is programmed in Locations 482 to 485 ( refer to *Auto Arming Time, page 133*), or when you enter Fault Analysis Mode by holding down [5].

**To set the new date and time:**

1. Enter your Master Code and press [6][AWAY]. Three beeps sound and the STAY and AWAY indicators flash.
2. Enter the day, month, year, hour, and minute in DD, MM, YY, HH, MM format (where DD is the day of the month, MM is the month of the year, YY is the year, HH is the hour of the day, and MM is the minute of the day) and press [AWAY].

Use 24:00 hour format when programming the hour of the day. Two beeps sound and the STAY and AWAY indicators are extinguished. If a long beep sounds, an error occurred when you entered the date and time.

**Example**

To set the date and time for 1st January 2014 at 10:30 PM, enter:  
[2 5 8 0 6][AWAY][0 1 0 1 1 4 2 2 3 0][AWAY]

### 7.2.11 Walk Test Mode

**See also**

- *Walk Test Mode, page 46*

### 7.2.12 Event Memory Recall Mode

**See also**

- *Event Memory Recall Mode, page 46*

### 7.2.13 System reset

Use this Master Code Function to reset the system manually.

**To reset the system:**

Enter your Master Code and press [9][9][8][9][AWAY]. Two beeps sound and the system is reset.

If the control panel powers up after it is powered down, the system resets automatically.

## 7.3 User Code Functions

**See also**

- *Partitioning, page 140*

### 7.3.1 Arm or Disarm both Areas at the Same Time

This User Code function operates only with partitioned systems and allows User Codes allocated to both Area 1 and Area 2 to arm or disarm both areas at the same time.

This feature allows a user assigned to both areas to arm or disarm the system by pressing one extra button on a partitioned codepad rather than entering a code on each partitioned codepad. To enable this feature, select Option 2 in Location 501 (refer to *Partitioning Options 2, page 140*).

**To arm or disarm both areas at the same time:**

Enter your User Code and press [0][AWAY]. Two beeps sound and both areas are armed or disarmed from AWAY Mode.

You can also arm/disarm both areas from a common codepad (assigned to both areas) with a common user code (assigned to both areas).

### 7.3.2 Arm or Disarm Single Area

**See also**

– *Arm or Disarm Single Area, page 48*

## 7.4 Hold-Down Functions

Hold-down functions allow easy activation of specific operations. When you hold down a button for 2 sec, two beeps sound and the corresponding function operates.

### 7.4.1 Arm the System in AWAY Mode

Holding down [#] until two beeps sound arms the system in AWAY Mode. This hold-down function operates only if you select Option 2 in Location 497 (refer to *Consumer Options 2, page 138*).

### 7.4.2 Arm the System in STAY Mode 1

Holding down [\*] until two beeps sound arms the system in STAY Mode 1. This hold-down function operates only if you select Option 2 in Location 497 (refer to *Consumer Options 2, page 138*).

If there was no alarm during the armed cycle, holding down [\*] a sec time disarms the system from STAY Mode 1. To enable single button disarming from STAY Mode 1 using this hold-down function, select Option 4 in Location 497.

If an alarm occurred or entry warning was activated, a valid User Code is required to disarm the system.

Refer to *Zone Options 2, page 98* for information on programming each zone to be automatically isolated in STAY Mode 1.

### 7.4.3 Arm the System in STAY Mode 2

Holding down [0] until two beeps sound arms the system in STAY Mode 2. This hold-down function operates only if you select Option 2 in Location 497 (refer to *Consumer Options 2, page 138*).

If no sound alarm occurred during the armed cycle, holding down [0] a sec time disarms the system from STAY Mode 2. To enable single button disarming from STAY Mode 2 using this hold-down function, select Option 4 in Location 497.

If an alarm occurred or entry warning was activated, a valid User Code is required to disarm the system.

For more information, refer to *Setting STAY Mode 2 Bypass Zones, page 45*.



**Notice!**

STAY Mode 2 does not work on a partitioned control panel system.

### 7.4.4 Horn Speaker Test

Holding down [1] until two beeps sound activates the horn speaker for a 2-sec burst. No other sounding device operates during this mode.

### 7.4.5

#### **Bell Test**

Holding down [2] until two beeps sound activates the internal screamers for a 2-sec burst. No other sounding device operates during this mode.

### 7.4.6

#### **Strobe Test**

Holding down [3] operates the strobe. No other device operates during this mode.

**To turn the strobe test on:**

Press and hold [3] until three beeps sound. The strobe flashes.

**To turn the strobe test off:**

Press and hold [3] until two beeps sound. The strobe stops flashing.

### 7.4.7

#### **Turning Day Alarm On and Off**

Holding down [4] turns Day Alarm on or off. If you want the STAY indicator to indicate the status of Day Alarm operation (enabled or disabled), select Option 8 in Location 496 (refer to *Consumer Options 1, page 137*). When this option is selected, the STAY indicator flashes once every 3 sec when Day Alarm is active.

**To turn Day Alarm on:**

Press and hold [4] until three beeps sound.

**To turn Day Alarm off:**

Press and hold [4] until two beeps sound.

### 7.4.8

#### **Fault Analysis Mode**

Several system faults can be detected by the control panel. When any of these faults are present, the FAULT indicator flashes and the codepad beeps once per minute. Refer to *Fault descriptions, page 36* for more information.

**To determine the type of fault:**

Press and hold [5] until two beeps sound.

The STAY and AWAY indicators flash. One or more zone indicators (1 to 16) light to indicate the type of fault that occurred.

**To exit from Fault Analysis Mode:**

Press [AWAY].

The STAY and AWAY indicators are extinguished and the system returns to the disarmed state.

### 7.4.9

#### **Initiate a Modem Call**

Holding down [6] until two beeps sound forces the control panel to dial the callback telephone number programmed in Locations 159 to 174 in an attempt to connect to the installer's remote computer.

The remote computer must be running the A-Link Software and must be set to Waiting for an Incoming Call. If no callback telephone number is programmed, holding down [6] has no effect.

**See also**

- *Call Back Telephone Number, page 71*

### 7.4.10

#### **Reset Latching Outputs**

Holding down [7] until two beeps sound resets any output that is programmed to remain on after it is activated. The output must be programmed with a latching polarity.

**See also**

- *Output Polarity, page 127*

### 7.4.11 Change the Codepad Buzzer Tone

Holding down [8] continuously changes the tone of the buzzer in the remote codepad. There are 50 different tones from 1500 Hz to 5000 Hz. In an installation with multiple codepads, you can set a different tone for each codepad.

**To change the buzzer tone:**

1. Press and hold [8] continuously. The tone of the buzzer increases in pitch.
2. Release [8] button when you hear the desired tone.



**Notice!**

Every time the system is powered down, you must reset each codepad to its individual tone using this function.

On partitioned control panels, this hold-down function also indicates the area to which the codepad belongs.

**To determine the area to which the codepad belongs:**

1. Press and hold [8] until two beeps sound. A zone indicator lights to show the area to which the codepad belongs.
  - Zone 1 = Area 1 codepad
  - Zone 2 = Area 2 codepad
  - Zone1,2 = Common Codepad for both Area1 and Area2
  - If no zone indicator lights, the codepad is set up incorrectly or an incorrect codepad is used.
2. Press [AWAY] to exit from this mode.

### 7.4.12 Send Test Report

Holding down [9] until two beeps sound transmits a Test Report (Contact ID Event Code 602) to test the reporting capabilities of the system without activating the sirens.

## 8 RF Keyfob Operations

The control panel can be remotely operated using RF keyfobs (hand-held remote radio transmitters).

You can use either a 2-button RFKF-TB keyfob or a 4-button HCT-4 or RFKF-FB keyfob to operate the system.

The 2-button and 4-button keyfobs can remotely arm and disarm the system in AWAY Mode or STAY Mode 1, and can activate remote Panic Alarms. The 4-button keyfob has the added ability to operate the control panel's programmable outputs to activate a garage door or outside lights, for example.

Before a keyfob can operate the control panel, you must teach the keyfob's radio code to the control panel. Refer to *Adding Remote Radio User Codes*, page 49 and *Deleting User/Radio Codes*, page 50 for more information.

When using a partitioned control panel, you must allocate the remote radio User Codes to one or more areas. Refer to *User code area assignments*, page 142 for more information.

### 8.1 Indications from RF Keyfob Operations

When using the 2-button or 4-button keyfob to operate the system, audible or visual indications, or both, can be provided by the horn speakers or the strobe. These indications allow you to operate the system from outside the premises with confidence.

The installer can program audible and visual indication beeps by selecting Options 4 and 8 in Location 492 (refer to *System Options 1*, page 134). You can adjust the speaker beep volume in Location 491 (refer to *Speaker Beep Volume*, page 133).

No of Beeps	System Status
One	System disarmed
Two	System armed in AWAY Mode
One two-tone beep	System armed in STAY Mode 1

**Table 8.1: Horn Speaker Indication Beeps for Remote Operations**

Strobe Duration	System Status
3 sec	System disarmed
6 sec	System armed in AWAY Mode
6 sec	System armed in STAY Mode 1

**Table 8.2: Strobe Indication for Remote Operations**

### 8.2 Remote Radio User Code Priority Levels

You can program the keyfobs to operate any of User Codes 1 to 32. You can assign priority levels to each keyfob, allowing the keyfob to arm the system only, or to arm and disarm the system, for example. Refer to *User Code Priority*, page 86 for more information.

Before a keyfob can operate the control panel, you must teach the keyfob's radio code to the control panel.



## 9 Remote Arming by Telephone

This feature allows you to arm your system from any remote location by telephone. For obvious security reasons, you cannot disarm the system using this method. A touch-tone telephone is required to use this feature.

### To remotely arm your system by telephone:

1. Call the telephone number to which your control panel is connected. When the control panel answers the incoming call, a short jingle sounds.
  - If you hear modem tones (a high tone and a low tone) when the control panel answers the incoming call, the system is programmed for remote arming by telephone. Wait for a pause in the tones and follow *Step 2* to arm the system remotely.
2. Press [\*] on the touch-tone telephone to arm the system. Two beeps sound to indicate that the system is armed in AWAY Mode.
3. Hang up the telephone. The system remains armed.

If the control panel does not answer the call, the ring count might be set to 0. If the control panel answers the call without modem tones, remote arming by telephone might not be enabled. To enable remote arming by telephone, select Option 2 in Location 177 (refer to *Communication Options 1, page 73*). To set the number of rings before the control panel answers, refer to *Ring Count, page 72*.



### Notice!

Using this method with a partitioned control panel arms both areas in AWAY Mode. Arming individual areas is not available with this method.

## 10 A-Link Plus Application

The remote connect feature of A-Link Plus allows you to establish a connection through the modem, network or direct connection from your computer to control panels.

### See also

- *Modem Connection, page 58*
- *Network Connection, page 59*
- *Direct Connection, page 60*

### 10.1 Modem Connection

#### 10.1.1 Remote Connection with Customer Control

Configure the control panel so that a remote connection can be established only when the client initiates it through the codepad.

1. Program the Call Back Telephone Number in Locations 159 to 174, refer to *Call Back Telephone Number, page 71*.
2. Disable Option 1 in Location 180, refer to *A-Link Plus Options, page 75*. The control panel is set so the client controls when a remote connection is established.
3. Program Ring Count in Location 175 as 1 – 13, refer to *Ring Count, page 72*.

#### To dial the remote computer:

Press and hold [6] until two beeps sound on the codepad.

#### 10.1.2 Remote Connection without Callback Verification

Remote connect without callback verification is useful if you must perform Upload/Download functions from multiple locations.



#### Notice!

Reduced security

Using the modem connection without callback verification feature reduces the security of the control panel.

There are two methods to disable callback verification.

#### Method One

Method one allows you to call the control panel from any remote location without the control panel calling back to the computer to establish a link. When using this method, the customer cannot initiate a modem call by holding down [6].

#### To program method one:

1. Program Locations 159 to 174 for the Call Back Telephone Number to 15.
2. Select Option 1 and disable Option 2 in Location 180.
3. Program Ring Count in Location 175 as 1 – 13.

The control panel allows a connection of the first call without calling the remote computer back.

#### Method Two

Method two allows you to program a callback telephone number so that the customer can still initiate a modem call when required. When you call the control panel from a remote location using the computer, the control panel does not call back the remote computer to establish a link.

#### To program method two:

1. Program the Call Back Telephone Number in Locations 159 to 174.
2. Select Option 1 and disable Option 2 in Location 180.
3. Program Ring Count in Location 175 as 1 – 13.

The control panel allows a connection of the first call without calling back the remote computer to make contact. It allows the customer to initiate a modem call by holding down [6].

### 10.1.3 Remote Connection with Callback Verification

Remote connect with callback verification offers the highest degree of data security by incorporating a two-level security check.

The first level is provided because the Installer Code and the Password for A-Link Plus/RSC must match those of the control panel. The second level of security exists because the control panel calls the programmed callback telephone number to establish the valid connection.

**To program the control panel for remote connection with callback verification:**

1. Program the Call Back Telephone Number in Locations 159 to 174.
2. Select Options 1 and 2 in Location 180.
3. Program Ring Count in Location 175 as 1 – 13.

### 10.1.4 Answering Machine Bypass Connection

Answering Machine Bypass allows a connection with the control panel for remote control or Upload/Download when an answering machine or facsimile machine is on the same telephone line.

**To program Answer Machine Bypass Connection:**

1. Connect the Modem to the computer.
2. Program A-Link plus Option in location 180 as 1.
3. Program Ring Count in location 175 as 14 or 15.
4. On the A-Link Plus Customer Information screen, select Answer Machine Bypass and set Modem Dial Time and Dial Interval.

Modem Dial Time is from the start of the first call to the end of the first call. This value sets the number of rings, noting that one ring is “Ring, Ring – Ring, Ring” and that one ring represents approximately 5 – 6 sec. Number of rings = Modem Dial Time / 6 (remainder + 1). Dial Interval is from the end of the first call to the start of the second call.

In A-Link Plus Customer Information screen, when Answer Machine Bypass 1 or 2 is enabled, A-Link Plus dials two times. Set appropriate Modem Dial Time and Dial Interval for the twice dialing to establish a successful answering machine bypass connection, preventing the answering machine or facsimile machine from answering the call. Refer to *Ring Count*, page 72 for more information on Answering Machine Bypass.



**Notice!**

Setting or not setting a callback number does not affect Answer Machine Bypass connection.

## 10.2 Network Connection

Use the IP connect feature to program a control panel using a portable computer. Telephone lines and modems are not required necessary.

**To program the network connection with IP:**

1. Connect a B426 network module to the control panel using the SDI2 bus.

2. In control panel programming parameters, program location 81 as 1, use but do not configure network module 1 through A-Link Plus. It is not necessary to program Location 180. The IP connect feature ignores this option.
3. From the B426 screen, set Web and Automation security as Enable.
4. From the A-Link Plus Customer Information screen, enter the full control panel IP address and control panel port number for the B426.
5. From the A-Link Plus Link screen, click Connect.

#### Network Connection with Domain Name

Use the Domain Name connect feature as another method to program the control panel using a portable computer.

#### To program the network connection with Domain Name:

1. Connect the B426 network module to the control panel using the SDI2 bus.
2. Program location 81 as 1, use but do not configure network module 1 through A-Link Plus.
3. From the B426 screen, set Web and Automation security as Enable.
4. From the A-Link Plus Customer Information screen, instead of full control panel IP address for the B426, enter the domain name, for example: Test123.BOSCH.com, and enter the full control panel port number for the B426.
5. From the A-Link Plus Link screen, click Connect.

## 10.3

### Direct Connection

The direct connect feature gives the installer a simple method to program the control panel using a portable computer. Because telephone lines and modems are not required, programming of the control panel is easily completed in min.

To use the direct connect feature, connect the Direct Link Adapter between the correct serial port on your compatible computer and the auxiliary module socket on the control panel.

To use the direct connect feature, it is not necessary to select Option 1 Location 180. The direct connect feature ignores this option.

## 10.4

### Options

#### See also

- *A-Link Plus Options, page 75*

## 10.5

### Configuring for email

Enabled external network modules and configured Email parameters through A-Link Plus, the control panel sends emails to assigned inbox through external network modules when events received.

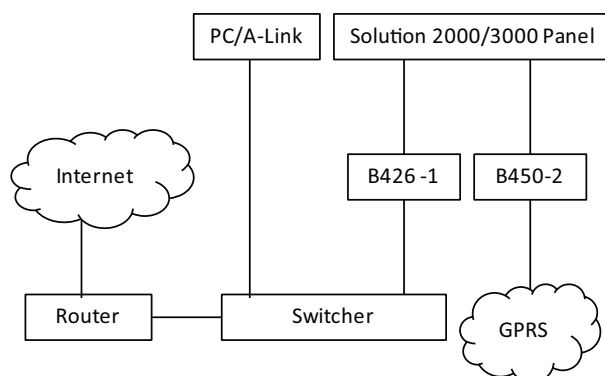

In the configuration diagram above, the control panel is programmed with Transmission Format as Email and two network modules are enabled to access mail server. It is an example of using B426 as network module 1 and B450 as network module 2. The wiring diagram is shown in above picture. “B426-1” means the rotary address switch of B426 is set to 1; “B450-2” means the rotary address switch of B450 is set to 2.

**See also**

- *External Network Modules, page 69*
- *A-Link Plus Software, page 21*

## 10.5.1 Configure through B426

**Notice!**

When Web Access Enable are set to Yes, B426 module parameters except Email parameters can be configured through web interface. Email parameters are configured through A-Link Plus and downloaded to the control panel.

Control panel can only write B426 parameters; it can't read B426 parameters with A-Link Plus.

**Notice!**

B426 parameters programmed through A-Link Plus can replace original B426 parameters when configure the B426 with the A-Link Plus. For this reason, keep and enter the original B426 parameters (IP address, port...etc.) to A-Link Plus.

Follow the steps below to configure necessary parameters to network module and send emails through the module.

**Step 1: Enable network module with a TEXT codepad**

1. Enter the Installer passcode (the default is 1234) and press [#] to enter Installer's Programming Mode. Press [7][2][1] to access the Network Module menu. Set the module to 1 – Used, Not Config.
2. Continue to press [-] until you return to *Confirm to Save Parameter Changes*.
3. Press [#] to save changes.

**Step 2: Configure the B426 network module**

If the B426 IP address is known, skip the step 2 and 4, and go to step 3 to access the B426 configuration web interface with the B426 IP address.

1. Power off the control panel.
2. Set the B426 rotary address switch to 9 to configure module parameters through B426 direct connection address 169.254.1.1
3. Install the jumper for Mode.
4. Change the computer network address to the same network segment with B426 address, such as 169.254.1.2
5. Connect the B426 to the computer with a network cable.
6. Power on the control panel.

**Step 3: Configure the B426 for the web**

1. From Internet Explorer on the computer, go to <http://169.254.1.1>. The B426 Login interface opens. Enter password “B42V2” to access the B426 configuration web interface.
2. Click Encryption and Security Settings, and change Web and Automation Security to Enable, then click OK to confirm.

3. Click Maintenance, change Web Access Enable to Yes, and change Panel Programming Enable to Yes, then click OK to confirm
4. Click Basic Network Settings, and configure IP address, port number and other network parameters. If static IP settings are used, you can note down the static IP settings for future use in A-Link Plus.
5. Click Save and Execute, then click OK to save the changes.
6. Click Logout to log out of the web configuration interface.
7. Power off the control panel.

#### Step 4: Restore connection

1. Change the computer network address to its previous value.
2. Remove the cable from the B426 to the computer, and restore the computer to original network connection.
3. Remove the Mode jumper.
4. Turn the rotary address switch to “1”.

#### Step 5: Configure A-Link Plus for Network Connect

1. When the B426 IP address is set as auto assigned and the IP address is unknown, you can access your router’s web interface and find the IP address of the B426, e.g. “192.168.226.127”. You can input the B426 IP address <https://192.168.226.127> in your PC IE to check some B426 parameters, notice the protocol is “https” not “http”.
2. Open A-Link Plus. Enter “admin” (lower case) as operator, “ADMIN” (all capitals) as password.
3. Click File > Communication Setting and select the Local IP Address of your computer. Enter the local port number.
4. Add a new customer, then open the customer interface.
5. Enter the customer information, and the Control Panel IP Address you found in current step 1, e.g. “192.168.226.127”.
6. Enter real port number in the Control Panel Port field. From the B426 network modules, you can find the real port number, such as 7700.
7. Open the Control Panel Configuration menu. Select Solution 2000 or Solution 3000 according to your control panel type.
8. Open the Link menu. Select Network Connect (TCP/IP SSL) and click Connect. A-Link Plus tries to connect to the control panel using the B426.

#### Step 6: Configure the Email through A-Link Plus

1. Click Upload from Control Panel when the connection is succeed. A-Link reads the parameters from the control panel and displays the parameter value differences between the A-Link database and the control panel database in a dialog box.
2. Click “Yes” to replace the parameter values in A-Link with the parameter values in the control panel.
3. Open the Control Panel Configuration menu and access the Solution2000/3000 configuration interface. Configure the Email parameters as indicated in the following table.
4. Return to the Link menu and reconnect the control panel. Click Download to Control Panel to complete the process. Check the parameters in the control panel to verify the parameter value changes were successfully downloaded

Configuration menu	Parameter	Value	Remark
Comm -> Receiver Config	Transmit Format	Email	Select corresponding Receiver
	Subscriber ID Number	001234	Email title (example)

Configuration menu	Parameter	Value	Remark
	IP + Port / Email	Receiver@163.com	Inbox (example)
Comm -> Network Config	Network Module 1	Use and configure	
Network module programming -> Module 1 # -> Basic Network Settings	IP Address		Enter original B426 parameters with DHCP auto assigned IP address or static IP address.
	Local Port Number		
	Subnet Mask		
	Default Gateway		
	DNS Server Address		
Network module programming -> Module 1 # -> Mail Information	Partial mail server name / url	smtp.163.com	Example
	Mail server port	465	
	Partial mail server user name	test@163.com	Sent Items (example)
	Mail server password	*****	Password of Sent Items
	Security options	Authenticate	
Network module programming -> Module 1 # -> Encryption and Security Settings	Enhanced Security Enable	Enable	
Network module programming -> Module 1 # -> Maintenance	Web Access Enable	Enable	Default value is Disable. Set to Enable if review module parameters through web interface is required.
	Panel Programming Enable	Enable	

Now the control panel parameters and module parameters changed through A-Link Plus can be downloaded to B426.

## 10.5.2 Configure through B450

Enabled external network modules and configured Email parameters through A-Link Plus or TEXT codepad, the control panel sends emails to assigned inbox through external network modules when events received.

### Step1: Install Tera term

Install Tera Term from the B450 CD.

### Step 2: Reset the B450/B442 modules to factory default

If the parameters of the B450/B442 are already set to their factory default values, skip the steps below and go to the next set of steps in *Configure Sent Items through Tera Term*.

1. Power off the control panel.
2. Set the rotary address switch of the B450 to "0".
3. Connect the B450 to the computer with a mini USB cable.
4. Power on the control panel.
5. Wait until the heartbeat LED on the B450 flashes 3 times per second and the status LED on the B442 flashes 1 time per second. The flashing indicates the startup process has completed.

6. Open the “Tera Term” software on the computer and select the serial port named B450 Config Interface.
7. Press [ENTER] to enter the B450 USB login interface.
8. Enter passcode “B450” and press [ENTER]. The main menu opens.
9. Enter “5” to select Reset To Factory Default. At the message “Are you sure (Y to default, N to exit)”, input “Y” to confirm. The interface returns to the main menu.

### Step 3: Configure Sent Items through Tera Term

1. Enter the B450 main menu.
2. Go to 3 Basic Configuration -> 7 GSM / GPRS Configuration -> Network Access Point Name, enter the GPRS access point name of network server.
3. Go to 3 Basic Configuration -> 8 Email Server Configuration, configure Sent Items with the example test@163.com.
  - Email Server Name / Address: smtp.163.com
  - Email Server Port Number: 465
  - Email Server Authentication / Encryption: Authenticate
  - Authentication User Name: test@163.com
  - Authentication Password: \*\*\*\*\*
4. Enter “8” to confirm Save and Exit to exit from Tera Term.
5. Power off the control panel.
6. Turn the rotary address switch to 2.
7. Power on the control panel.

### Step 4: Configure Email related parameters through A-Link Plus

1. Open A-Link Plus, go to Control Panel Configuration menu. Select Solution 2000 or Solution 3000 according to your control panel type.
2. Configure email related parameters.

Configuration menu	Parameter	Value	Remark
Comm -> Receiver Config	Transmit Format	Email	Select corresponding Receiver
	Subscriber ID Number	001234	Email title (example)
	IP + Port / Email	Receiver@163.com	Inbox (example)
Comm -> Network Config	Network Module 2	Use, but not configure	Select corresponding module

3. Open the Link menu, select a connect method and click Connect. Click Download to Control Panel when the connection is successful to complete the process. Except A-Link Plus, a TEXT codepad can be used to configure above email related parameters.



## 11 Communication Information

This section outlines the programming information required for the control panel when communicating with a base station receiver. These parameters specify the telephone numbers to call, transmission formats, and transmission speeds.

The control panel can report event information from two on-board communicators / modules. The first communicator reports to Receiver 1 and the second communicator reports to Receiver 2. You can program each communicator with two separate telephone numbers, reporting format type, and Subscriber ID Number.

### Example

You can set up Communicator 1 to notify alarms in Domestic Dialing Format to Receiver 1 and set up Communicator 2 to report to a base station receiver in Contact ID Format only if Communicator 1 is unsuccessful.

### To program a telephone number:

When programming a telephone number, you can program a 0 as a 0. Each location in the primary, secondary, and callback telephone numbers stores one digit of the telephone number.

You must insert a terminator (15) at the end of a telephone number to indicate to the communicator the end of the telephone number is reached. The dialing sequence terminates when a 15 appears.

### Example

To program the telephone number 9672 1055 as the Primary Telephone Number for Receiver 1, program the following sequence into Locations 000 to 015: [9 6 7 2 1 0 5 5 15 15 15 15 15 15 15]

To enter a 4-sec pause in the dialing sequence, program a 13. A pause might be necessary when the module communicates through an old (slower) telephone exchange or when a PABX system is in place.

### Example

To program the number 02 pause 9672 1055, enter: [0 2 13 9 6 7 2 1 0 5 5 15 15 15 15 15]. How to program the numbers, keys, and functions for a telephone number, refer to below table.

Digit Required	Number to Program	Digit Required	Number to Program
0	0	8	8
1	1	9	9
2	2		
3	3	*	* 1
4	4	#	* 2
5	5	4-sec Pause	* 3
6	6		
7	7	Terminator	* 5

**Table 11.1: Dialing Digits**

## 11.1 Primary Telephone Number for Receiver 1 and Receiver 2

Item	Location	Option	Default	New
Phone Number 1 - Receiver 1	0000 - 0015	15 = Telephone termination	15	
Phone Number 1 – Receiver 2	0040 - 0055	15 = Telephone termination	15	

When the control panel transmits a report, the panel dials the Primary Telephone Number to contact the monitoring station, for example. If the call is successful, the relevant information is transmitted and the communicator returns to Standby Mode.

If unsuccessful, the communicator attempts two more calls using the Primary Telephone Number for Receiver 1. If these calls are unsuccessful, the communication module calls the Secondary Telephone Number for Receiver 1 up to three times. If the dialing sequence is still unsuccessful, the control panel repeats this sequence by dialing the Primary and Secondary Telephone Numbers for Receiver 2 (if they are programmed).

If the first six attempts are unsuccessful and no telephone numbers for Receiver 2 are programmed, this procedure is repeated every 10 min continuously till the report is transmitted successfully.

Contact your monitoring station for the correct telephone numbers before you program these locations. With a text codepad, go to menu 711 First Phone Number to program the primary telephone numbers.

## 11.2 Secondary Telephone Number for Receiver 1 and Receiver 2

Item	Location	Option	Default	New
Phone Number 2 – Receiver 1	0016 - 0031	15 = Telephone termination	15	
Phone Number 2 – Receiver 2	0056 – 0071	15 = Telephone termination	15	

For programming information, refer to *Primary Telephone Number for Receiver 1 and Receiver 2*, page 66. With a text codepad, you go to menu 712 Second Phone Number to program the secondary telephone numbers.

## 11.3 Transmission Format for Receiver 1 and Receiver 2

Item	Location	Option	Default	New
Transmission Format – Receiver 1	0033	0 = Not used	1	
Transmission Format – Receiver 2	0073	1 = Contact ID 4 = Domestic 5 = Conettix IP 6 = SIA Fast 7 = SIA Slow 8 = CSVIP 9 = Email	1	

Select the desired transmission format here. These locations select the data format used to transmit to the base station receiver. These locations also allow you to configure the control panel for domestic formats.

value 5 – Conettix IP (for China only)

value 8 – CSVIP (for Australia only)

With a text codepad, go to menu 713 Transmit Format to set the transmission for Receiver 1 and Receiver 2.

## 11.4 Subscriber ID Number for Receiver 1 and Receiver 2

Item	Location	Option	Default	New
Subscriber ID Number – Receiver 1	0034 - 0039		0	
Subscriber ID Number – Receiver 2	0074 – 0079		0	

The Subscriber ID Number is transmitted to identify the calling control panel. Enter the Subscriber ID Number in the six locations provided for each receiver.

When using Domestic Dialing Format, the number of identification beeps is determined by the value programmed in Location 039 (Receiver 1) and Location 079 (Receiver 2). This value allows the identification of up to 10 different control panels that call the same telephone number.

With a text codepad, go to menu 714 Subscriber ID Number to set Subscriber ID Number for Receiver 1 and Receiver 2.

### Example

To program the Subscriber ID Number as 4729, program the six locations as: [0 0 4 7 2 9].

## 11.5 IP Items for Receiver 1 and Receiver 2

Item	Location	Option	Default	New
IP + Port / Email – Receiver 1	1000 - 1099			
CSVIP User Name and Password – Receiver 1	1100 - 1163			
IP + Port / Email – Receiver 2	1200 – 1299			
CSVIP User Name and Password – Receiver 2	1300 – 1363			

CSVIP User Name and Password are valid only when CSVIP is select as transmission format. For IP + Port / Email, enter IP address and port number when CSVIP is select; enter email address when Email is select as transmission format.

### Program IP items with A-Link Plus Software or text codepad

1. Select **Comm** -> **Receiver Config** -> **Transmit Format**, select **CSVIP** for Receiver 1 or Receiver 2.
2. Select **Comm** -> **Receiver Config** -> **Subscriber ID Number**, enter Subscriber ID Number.
3. Select **Comm** -> **Network Config**, select module 1 or 2 as **Use, do not configure**.
4. Select **Comm** -> **Receiver Config** -> **IP + Port / Email**, enter IP and the Port, for example, **192.168.226.17:12000**.
5. Select **Comm** -> **Receiver Config** -> **CSVIP User Name And Password**, enter CSVIP User Name and Password:
  - Both user name and password, enter as user name with comma and password with comma, for example, **USER 1, 2580,.**
  - Only user name, enter as user name with two commas, for example, **USER 1,,.**
  - Only password, enter as comma, followed by password with comma, for example, **, 2580,.**
  - No user name and password, only enter two commas.

For A-Link Plus, enter up to 32 case sensitive alphanumeric characters for CSVIP User Name and Password directly through keyboard.

For text codepad, enter sensitive alphanumeric characters as below table.

Codepad Key	Characters / Function	Codepad key	Characters / Function
▲	Step back former character	6	[ m ], [ n ], [ o ], [ 6 ]
_	Exit item setting	7	[ p ], [ q ], [ r ], [ s ], [ 7 ]
▼	Move to next character	8	[ t ], [ u ], [ v ], [ 8 ]
1	[ . ], [ @ ], [ : ], [ _ ], [ 1 ]	9	[ w ], [ x ], [ y ], [ z ], [ 9 ]
2	[ a ], [ b ], [ c ], [ 2 ]	*	Case shift
3	[ d ], [ e ], [ f ], [ 3 ]	0	[ Space ], [ , ], [ / ], [ ? ], [ 0 ]
4	[ g ], [ h ], [ i ], [ 4 ]	#	Confirm item setting
5	[ j ], [ k ], [ l ], [ 5 ]		

**Table 11.2: Alphanumeric characters on text codepad**

#### Program Email with A-Link Plus

Refer to *Configure through B426, page 61* for more information to configure Email through A-Link Plus.

With a text codepad, go to menu 715 IP + Port / Email and 716 CSVIP user name and password to set IP items for Receiver 1 and Receiver 2.

## 11.6 Conettix Items for Receiver 1 and Receiver 2

Item	Location	Option	Default	New
Anti-replay	1400	1 = Anti-replay for Receiver 1 Enable 2 = Anti-replay for Receiver 2 Enable 4 = Reserved 8 = Reserved	3	
ACK Wait Time – Receiver 1	1401 - 1402	0 – 9 = 0 – 99 sec.	5	
Heart Beat Time – Receiver1	1403 - 1404	1 – 9 = 1 – 99 min.	1	
ACK Wait Time – Receiver 2	1405 - 1406	0 – 9 = 0 – 99 sec.	5	
Heart Beat Time – Receiver2	1407 - 1408	1 – 9 = 1 – 99 min.	1	

These three Conettix items are only available when the Transmission Format is selected as Conettix IP.

#### Conettix Anti-replay

This location has two programming options. You can select any combination of the options by programming a single value. Calculate this value by adding the option bit numbers together. Default is to enable Anti-replay for both receivers.

#### Conettix ACK Wait Time

ACK Wait Time set the time the control panel receives an acknowledgment from the receiver. If the time is exceed and the acknowledgment is not yet received, the control panel assumes the attempt is a failure and prepares for next attempt.

### Conettix Heartbeat Time

Heartbeat time set the interval for network supervision. When the time is due, the control panel transmits supervising signals to the receiver to ensure the network connect is normal. With a text codepad, go to menu 717 Conettix ACK wait time, 718 Conettix heart beat time and 719 Conettix anti-replay enable to set Conettix parameters for Receiver 1 and Receiver 2.

## 11.7 External Network Modules

Item	Location	Option	Default	New
External Network Module 1	0081	0 = Not used 1 = Use, do not configure	0	
External Network Module 2	0082	2 = Use and configure	0	

Location 81 enables/disables the external network module 1.

Location 82 enables/disables the external network module 2.

If with text codepad, go to menu 721 Network Module to enable/disable the network module. When the value of the location above is 0, the external network module is disabled accordingly.

When the value is 1, the corresponding network module is enabled, but the control panel won't configure parameters of network module.

When the value is 2, the corresponding network module is enabled, and the control panel will configure the relevant parameters to network module.

Location 81	Location 82	Reports to Receiver 1	Reports to Receiver 2	Will control panel configure parameters of Network Module?
Value = 0	Value = 0	No report will be sent by network module.		No
Value = 1	Value = 0	Sent by network module1		No
Value = 2	Value = 0			Configure Network Module 1
Value = 1	Value = 1	Sent by network module 1	Sent by network module 2	No
Value = 1	Value = 2			Configure Network Module 2
Value = 2	Value = 1			Configure Network 1
Value = 2	Value = 2			Configure Both Network Modules
Value = 0	Value = 1	Invalid Setting		
	Value = 2			

## 11.8 Password for A-Link Connection

Item	Location	Option	Default	New
Password for A-Link Plus/RSC Connection	0083 - 0092		0	

These locations store up to 10-digit password for A-Link or RSC connection. The A-Link / RAC Password in the A-Link Plus software must be the same one as programmed in these locations.

Defaulted password is 0000000000 for both in control panel and in A-Link Plus.

## 11.9 DTMF Timing Compensation

Item	Location	Option	Default	New
DTMF Timing Compensation	0111	0 = Disable 1 – 9 = Timing compensation	0	

DTMF Timing Compensation is used to pre-compensate signal distortion generated by digital telephone applications (Fiber telephone, VoIP, or GSM module). It can help to reduce failures in alarm communication.

DTMF Timing Compensation works only with Contact ID format. Defaulted 0 is to disable this function and the communication capabilities remains the same .

Enable this function by selecting value from 1 to 9 when it is really necessary. 9 is for highest compensation, but not higher is better. Select the optimal value by bidirectional testing from 4.

## 11.10 Country Codes

Item	Location	Option	Default	New
Country codes	0112	0 = Australia 1 = China	0	

Value 0 is also for Singapore.

## 11.11 Telco Arming Sequence

Item	Location	Option	Default	New
Telco Arming Sequence (Call Forward On)	0113 - 0142	15 = Telephone termination	15	

These locations allow you to activate call diversion automatically on your telephone when you arm the system in AWAY Mode.

When the Telco Arming Sequence is activated after arming the system in AWAY Mode, the control panel redirects all calls to your mobile phone.

Contact your telecommunications provider for more information on Call Forward operations.

Digit Required	Number to Program	Digit Required	Number to Program
0	0	8	8
1	1	9	9
2	2		
3	3	*	* 1
4	4	#	* 2
5	5	4-sec Pause	* 3

Digit Required	Number to Program	Digit Required	Number to Program
6	6		
7	7	Terminator	* 5

**Table 11.3: Dialing Digits**

**To turn call forward (immediate) on, enter:**

[\* 2 1][forwarding telephone number][#]

**Example**

To immediately forward all incoming calls to the telephone number 96721055 after arming the system in AWAY Mode, program:

[11 2 1 9 6 7 2 1 0 5 5 12 15 15 15 15 15 15 15 15 15 15 15 15 15 15 15]

**To turn call forward (no answer) on, enter:**

[\* 6 1][forwarding telephone number][#]

**Example**

To forward all incoming calls, when there is no answer, to the telephone number 96721055 after arming the system in AWAY Mode, program:

[11 6 1 9 6 7 2 1 0 5 5 12 15 15 15 15 15 15 15 15 15 15 15 15 15 15 15 15]

## 11.12 Telco Disarming Sequence

Item	Location	Option	Default	New
Telco Disarm Sequence (Call Forward Off)	0143 - 0158	15 = Telephone termination	15	

These locations allow you to deactivate call diversion automatically on your telephone when you disarm the system from AWAY Mode.

**To turn call forward (immediate) off, enter:**

[# 2 1 #]

**Example**

To disable call forward (immediate) after disarming the system from AWAY Mode, program:

[12 2 1 12 15 15 15 15 15 15 15 15 15 15]

To turn call forward (no answer) off, enter: [# 6 1 #]

**Example**

To disable call forward (no answer) after disarming the system from AWAY Mode, program:

[12 6 1 12 15 15 15 15 15 15 15 15 15 15]

## 11.13 Call Back Telephone Number

Item	Location	Option	Default	New
Call Back Telephone Number	0159 - 0174	15 = Telephone termination	15	

The locations store the telephone number to call when Upload/Download is requested or the user holds down [6] to initiate a modem call from the control panel to establish a communications link with the remote computer. The computer must be running the A-Link Plus software and must be set to Waiting for an Incoming Call. The Call Back Telephone Number is also required if Remote Connection with Callback Verification is required.

## 11.14 Ring Count

Item	Location	Option	Default	New
Ring Count	0175	0 = Panel does not answer 1 - 13 = Number of rings until panel answers 14 = Answering machine bypass 2 15 = Answering machine bypass 1	8	

This location sets the number of rings before the control panel answers an incoming call. Set this count to an acceptable level, noting that one ring is “Ring, Ring – Ring, Ring” and that a Ring Count of 10 represents approximately 60 sec. This location has an effect only if Remote Arming, remote Upload/Download using A-Link Plus, or both are enabled. Programming this location to 0 prevents the control panel from answering incoming calls regardless of other programmed options.

### Answering Machine Bypass

Answering Machine Bypass allows a connection with the control panel for Remote Arming or Upload/Download when an answering machine or facsimile machine is on the same telephone line. Answering Machine Bypass has two different methods. Program a 14 to use the secondary method only when there is a large amount of traffic on the line (at a home office, for example). This method reduces the chance of the control panel incorrectly answering an incoming call.

Programming the Ring Count to 15 enables Answering Machine Bypass in the primary mode. When calling the control panel, allow the telephone to ring no more than four times and then hang up. If after 8 seconds you call again within 45 sec, the control panel answers the call on the first ring and the connection is established. This prevents the answering machine or facsimile machine from answering the call. To enable Answering Machine Bypass only when the system is armed, select Option 4 in Location 177 (refer to *Communication Options 1*, page 73).

Program the Ring Count to 14 to enable Answering Machine Bypass in the secondary mode. In this case, call the control panel and allow the phone to ring no more than twice and hang up. Wait a minimum of 8 sec and call the control panel again within 45 sec. The control panel answers on the first ring. If you do not wait the 8 sec, the control panel does not answer the call. To enable Answering Machine Bypass only when the system is armed, select Option 4 in Location 177.



### Notice!

Set the Ring Count for the answering machine or facsimile machine to a value greater than two rings. Four to six rings is preferred.

Program a 0 into this location to disable the control panel from answering an incoming call.



## 11.15 Telephone Line Fail Options

Item	Location	Option	Default	New
Telephone Line Fail Options	0176	1 = Display FAULT Indicator when telephone line fails 2 = Sound alarm when system is armed 4 = Sound alarm when system is disarmed 8 = Reserved	0	

This location has three options. You can select any combination of these options by programming a single value. Calculate this value by adding the option bit numbers together. The control panel monitors the telephone line. If the telephone line is cut or disconnected for longer than 40 sec, the control panel lights the FAULT indicator on the codepad. The FAULT indicator is extinguished after the telephone line is restored for longer than 40 sec.



### Notice!

Options 2 and 4 do not operate unless you also enable Option 1.

#### 1 – Display FAULT indicator when the Telephone Line Fails

When this option is selected, the FAULT indicator flashes and the codepad buzzer beeps once per min if the control panel detects that the telephone line is disconnected.

#### 2 – Sound Alarm when System Is Armed

You must also select Option 1 to use this option. If the control panel detects that the telephone line is disconnected when the system is armed, the horn speaker, bell, and strobe outputs are activated. If only one audible alarm per arming cycle is required, select the Lockout Telephone Line Fail Alarm option (2) in Location 179 (refer to *Communication Options 3*, page 75).

#### 4 – Sound Alarm when System Is Disarmed

You must also select Option 1 to use this option. If the control panel detects that the telephone line is disconnected when the system is disarmed, the horn speaker, bell, and strobe outputs are activated. If only one audible alarm per arming cycle is required, select the Lockout Telephone Line Fail Alarm option (2) in Location 179.



### Notice!

If you program 7 in this location, the horn speaker, bell, strobe, and outputs are all activated when the system is armed or disarmed.

## 11.16 Communication Options 1

Item	Location	Option	Default	New
Communication Options 1	0177	1 = Reporting functions allowed 2 = Remote arming by telephone allowed 4 = Answering machine bypass only when armed 8 = Use Bell 103 for FSK format (Disabled = CCITT V21)	9	

#### 1 – Reporting Functions Allowed

When selected, this option operates for all reporting functions.

If you do not select this option, the communication does not operate.

Upload/Download using the A-Link-Plus software and telephone remote arming remains operational regardless of this setting.

#### **2 – Remote Arming by Telephone Allowed**

If you select this option, you can remotely arm the system using a standard telephone by pressing [\*] on your touch-tone telephone.

Forced arming is automatically assumed when this feature is used.

#### **4 – Answering Machine Bypass Only When Armed**

Select this option to enable the Answering Machine Bypass feature when the system is armed.

When the system is disarmed, the control panel does not answer any incoming calls. This option is beneficial in high telephone traffic installations where the control panel could answer an incoming call.

#### **8 – Use Bell 103 for FSK Format (Disabled=CCITT V21)**

If this option is selected, the control panel uses the BELL 103 transmission frequency at 300 baud. If this option is not selected, the control panel uses the CCITT V21 transmission frequency at 300 baud.

## 11.17 Communication Options 2

Item	Location	Option	Default	New
Communication Options 2	0178	1 = Arm/Disarm Reports only if alarmed 2 = STAY Mode Arm/Disarm Reports Enable 4 = Delay siren until transmission complete 8 = Extend handshake wait time from 30 to 60 sec.	0	

#### **1 – Arm/Disarm Reports Only if Previous Alarm**

When selected, an Disarm Report is transmitted to the base station receiver when the system is disarmed after an alarm occurred. When the system is armed, an Arming Report is transmitted. An Arm or Disarm Report does not report again until the system registers another alarm.

For a partitioned control panel, an Arm/Disarm Report is sent only for the area in which the alarm occurred.



#### **Notice!**

If the system is disarmed when an alarm occurs, only an Arm Report is sent the next time the system is armed.

A User Code with a priority set to Always Send Arm/Disarm Reports overrides this feature (Arm/Disarm Reports are always sent for that User Code).

#### **2 – STAY Mode Arm/Disarm Reports Enable**

Select this option if Arm/Disarm Reports are required when the system is armed in STAY Mode 1 or STAY Mode 2.

If this option is selected, a Partial Arm Report is sent when the system is armed in STAY Mode 1 or STAY Mode 2.

#### **4 – Delay Siren until Transmission Complete**

If this option is selected, horn speaker, bell, and strobe outputs are not activated until after the control panel sends the message and the base station receiver sends a kiss-off back to the control panel. If multiple messages are transmitted, the sirens are activated after the last kiss-off is sent.

If a Codepad Panic, Codepad Fire, or Codepad Medical Alarm is activated, horn speaker, bell, and strobe outputs operate immediately.

#### **8 – Extend Time to Wait for Handshake from 30 to 60 Sec**

By default, the control panel waits approximately 30 sec for receipt of a valid handshake tone after it dials the monitoring station. The handshake tone indicates to the control panel that it reached the monitoring station and can now transmit its messages. Selecting this option extends this wait time from 30 sec to 60 sec.

## **11.18 Communication Options 3**

Item	Location	Option	Default	New
Communication Options 3	0179	1 = Set DTMF dialing pluses to 1 digit/sec 2 = Lockout telephone line fail alarm 4 = Reserved 8 = Reserved	2	

#### **1 – Set DTMF Dialing Pulses to 1 Digit/Sec**

If this option is not selected, the DTMF dialing format dials at 5 digits per sec (that is, 100 ms tone, 100 ms pause, 100 ms tone, 100 ms pause).

If this option is selected, the DTMF dialing format dials at the rate of 1 digit per sec (that is, 500 ms tone, 500 ms pause).

#### **2 – Lockout Telephone Line Fail Alarm**

Selecting this option allows an audible alarm only once per arming cycle when the control panel detects the telephone line is cut or disconnected. This option does not follow the Swinger Shutdown Count for Siren, in which you can program the number of times a zone can sound an alarm during an arming cycle. Use Location 176 to program the telephone line fault options, refer to *Telephone Line Fail Options*, page 73.

## **11.19 A-Link Plus Options**

Item	Location	Option	Default	New
A-Link Plus Options	0180	1 = Enable upload/download using A-Link 2 = Enable A-Link callback 4 = Terminate A-Link connection on alarm 8 = Reserved	3	



#### **Notice!**

The A-Link options are available only for link through the telephone line. The options are not related to connection through network or direct connection.

#### **1 – Enable Upload/Download Using A-Link**

Select this option to use the A-Link Plus software to initiate connection with the control panel to program and control the control panel remotely. The control panel does not respond to A-Link if this option is not selected.

Control panel establishes connection with A-Link Plus through callback method regardless of this setting.

#### **2 – Enable A-Link Call Back**

If this option is selected and a callback telephone number is programmed, the remote programming computer must be connected to the telephone line programmed in the callback telephone number in Locations 159 to 174.

If this option is not selected, the installer can connect to a customer's control panel from any remote location for Upload/Download operations without the control panel calling back to the remote computer. The customer can initiate a modem call from the codepad by holding down [6].

#### **4 – Terminate A-Link Connection on Alarm**

If an alarm occurs when the control panel is communicating with a remote computer using the A-Link Plus software over the telephone line, the A-Link session is terminated and the relevant alarm message is transmitted to the base station receiver.

If an alarm occurs that does not have to be reported to the base station receiver, the session is not terminated.

## **11.20 Domestic Dialing**

The locations of the primary and secondary telephone numbers for Receiver 1 or Receiver 2 are used for base station and domestic dialing.

### **11.20.1 Domestic Dialing Function**

When the control panel is activated into alarm, it dials the primary number. If a busy tone is detected, or the call is not acknowledged, the control panel hangs up and dials the primary number again. The control panel will try dialing the primary number up to 3 times. If all three attempts are unsuccessful, the control panel tries dialing the secondary number. The control panel will try the secondary number up to 3 times. If all dialing attempts are unsuccessful, the control panel discontinues dialing. If another alarm is activated, the dialing sequence above starts over again.

If a busy tone is not detected, the control panel assumes the telephone was answered and sends its transmission. The transmission sequence consists of an identification beep, followed by a siren tone and a pause. The transmission sequence is repeated until the control panel receives an acknowledgment tone during the (3 sec about) pause. The control panel automatically hangs up after the transmission sequence is repeated 10 times. If more than one control panel dials to the same telephone number, the identification beep allows the customer to verify the control panel that called.

The identification beep is programmed in Location 039 of the Subscriber ID Number for Receiver 1 or Location 079 of the Subscriber ID Number for Receiver 2.

#### **Notice!**



When set up for Domestic Dialing Format, the control panel attempts a maximum of six calls for each alarm event (3 on the primary number and 3 on the secondary number of a receiver). This count includes any unsuccessful calls. The counter is reset if the zone is reactivated and the control panel attempts an additional six calls. The control panel stops dialing after an any successful call. The control panel also stops dialing if a valid User Code is entered at the codepad. If both Receiver 1 and Receiver 2 are programmed for domestic dialing, the maximum number of calls for each alarm event is twelve.

#### **To acknowledge domestic dialing:**

If the received call is not acknowledged during any of the transmission pauses by pressing the [\*] button on a touch-tone telephone, the control panel repeats its transmission sequence 10 times and then it hangs up. If the call is successfully acknowledged during 10 times, the control panel hangs up and makes no more calls for that event.

## 11.20.2 Setting Up and Programming Domestic Reporting

Programming the control panel for domestic reporting is extremely simple when using the Installer's Programming Command 965.

### To set up the control panel for domestic dialing:

1. Enter the Installer Code and press [AWAY] to enter Installer's Programming Mode. Two beeps sound and the STAY and AWAY indicators flash.
2. Enter [9 6 5] and press [AWAY]. Two beeps sound. The control panel is now set up for Domestic Dialing Format for Receiver 1.
3. Enter [9 6 0] and press [AWAY] to exit from Installer's Programming Mode. Two beeps sound and the STAY and AWAY indicators are extinguished. The system returns to the disarmed state.
4. Or skipping steps 1 - 3, with a text codepad, enter the installer code and press [AWAY] to enter Installer's Programming Mode, go to menu 747 Set Up Domestic Dialing Format, then exit with saving.
5. To program your telephone numbers, enter your Master Code and press [2][AWAY]. Three beeps sound and the STAY and AWAY indicators flash. There are 4 telephone number locations. Numbers 1 and 2 are for receiver 1. Numbers 3 and 4 are for receiver 2. After the [965] command, the receiver 1 format is domestic and receiver 2 format is contact ID. Press [1] to view and set/modify telephone number 1 followed by [AWAY] to complete the process. If you still want to set telephone number 2, you will have to enter Master Code and press [2][AWAY], then press [2] to select number 2. If any telephone numbers are already programmed, they are displayed one digit at a time using the codepad indicators. If no telephone numbers are programmed, two additional beeps sound after you enter this mode. These two beeps normally sound after the last digit of the last phone number is displayed.
6. Enter the digits for telephone number 1, one digit at a time. As you enter each digit, the corresponding codepad indicator lights. If using a text codepad, the programmed number and new entered number are displayed.
7. After the last digit of the telephone number, press [AWAY] to exit from this mode.
8. Repeat *Step 5-7* for each additional phone number.

Digit Required	Number to Program	Digit Required	Number to Program
0	0	8	8
1	1	9	9
2	2		
3	3	*	[STAY]1
4	4	#	[STAY]2
5	5	4 sec pause	[STAY]3
6	6		
7	7	terminator	[STAY]5

**Table 11.4: Domestic Dialing Digits**

## 11.21 Reporting Formats

The control panel provides a number of transmission formats for its reporting and communication features. Program the transmission format for Receiver 1 in Location 033 and the transmission format for Receiver 2 in Location 073 (refer to *Transmission Format for Receiver 1 and Receiver 2*, page 66).

The transmission format can also be selected with location options to specify how to transmit the information to the base station receiver. If Contact ID, or Domestic, or SIA format is selected, the information is transmitted by telephone line; if SIA Fast format is selected, the transmission baud is SIA 300; if SIA Low format is selected, the transmission baud is SIA 110; if IP or Email format is selected, the information is transmitted to network by external network modules.

The control panel is set at the factory to report in the Contact ID Format.

### 11.21.1

#### Contact ID Format

Contact ID Format can identify hundreds of protection zones by their unique codes. This format provides a single-digit Event Qualifier and a three-digit Event Code that quickly identifies the reported condition.

In general, Contact ID Format is very simple because most of the Event Codes and Point ID Codes are predefined. The base station software usually can identify an alarmed zone by its Point ID Code and usually pays little attention to the Event Code.

Contact ID format is ACCT MT Q EEE GG CCC S.

Format	Description
ACCT	Four-digit Subscriber ID Number
MT	Message type, fixe das 18
Q	Event Qualifier, which provides specific event information: 1 – New event or disarming 3 – New restore or arming
EEE	Event Code (comprised of three hex digits)
GG	Group Number or Area Number (comprised of two hex digits)
CCC	Point ID Number or User Number (comprised of three hex digits), 000 means no point or user information
S	Checksum digit

**Table 11.5: Contact ID Format Breakdown**

### 11.21.2

#### SIA Format

SIA is a special format of using frequency shift keying (FSK) rather than a pulse to communicate quickly.

SIA format is # AAAAAA N GGGGGG EE CCCCCC.

Format	Description
#	Begin of Subscriber ID Number
AAAAAA	Subscriber ID Number
N	Begin of event
GGGGGG	Group / Area Number , User Number or Codepad Number

Format	Description
EE	Event Code
CCCCC	Event Qualifier

Table 11.6: SIA Format Breakdown

### 11.21.3 System Reporting List

Index	Event Description	CID Event Code	CID Point ID	SIA Event Code	String (Email / Codepad Display)
1	ZoneAlarm	1130	Zone 1 – 8 / 16	BA	Z\$\$ Alarm
2	ZoneAlarmRestore	3130	Zone 1 – 8 / 16	BH	Z\$\$ Alarm Restore
3	ZoneTrouble	1380	Zone 1 – 8 / 16	BT	Z\$\$ Trouble
4	ZoneTroubleRestore	3380	Zone 1 – 8 / 16	BJ	Z\$\$ Trouble Restore
5	ZoneBypass	1573	Zone 1 – 8 / 16	BB	Z\$\$ Bypass
6	ZoneUnBypass	3573	Zone 1 – 8 / 16	BU	Z\$\$ UnBypass
7	24HrZoneAlarm	1133	Zone 1 – 8 / 16	BA	24Hr Z\$\$ Alarm
8	24HrZoneAlarmRestore	3133	Zone 1 – 8 / 16	BH	24Hr Z\$\$ Alarm Restore
9	24HrFireZoneAlarm	1110	Zone 1 – 8 / 16	FA	24Hr Fire Z\$\$ Alarm
10	24HrFireZoneAlarmRestore	3110	Zone 1 – 8 / 16	FH	24Hr Fire Z\$\$ Alarm Restore
11	24HrMedicalZoneAlarm	1100	Zone 1 – 8 / 16	MA	24Hr Medical Z\$\$ Alarm
12	24HrMedicalZoneAlarmRestore	3100	Zone 1 – 8 / 16	MH	24Hr Medical Z\$\$ Alarm Restore
13	24HrPanicZoneAlarm	1120	Zone 1 – 8 / 16	PA	24Hr Panic Z\$\$ Alarm
14	24HrPanicZoneAlarmRestore	3120	Zone 1 – 8 / 16	PH	24Hr Panic Z\$\$ Alarm Restore
15	24HrHoldUpZoneAlarm	1122	Zone 1 – 8 / 16	HA	24Hr Hold-Up Z\$\$ Alarm
16	24HrHoldUpZoneAlarmRestore	3122	Zone 1 – 8 / 16	HH	24Hr Hold-Up Z\$\$ Alarm Restore
17	24HrTamperZoneAlarm	1137	Zone 1 – 8 / 16	TA	24Hr Tamper Z\$\$ Alarm
18	24HrTamperZoneAlarmRestore	3137	Zone 1 – 8 / 16	TR	24Hr Tamper Z\$\$ Alarm Restore
19	24HrZoneTrouble	1380	Zone 1 – 8 / 16	BT	24Hr Z\$\$ Trouble
20	24HrZoneTroubleRestore	3380	Zone 1 – 8 / 16	BJ	24Hr Z\$\$ Trouble Restore
21	24HrMedicalZoneTrouble	1380	Zone 1 – 8 / 16	MT	24Hr Medical Z\$\$ Trouble
22	24HrMedicalZoneTroubleRestore	3380	Zone 1 – 8 / 16	MJ	24Hr Medical Z\$\$ Trouble Restore
23	24HrTamperZoneTrouble	1380	Zone 1 – 8 / 16	TT	24Hr Tamper Z\$\$ Trouble

Index	Event Description	CID Event Code	CID Point ID	SIA Event Code	String (Email / Codepad Display)
24	24HrTamperZoneTroubleRestore	3380	Zone 1 – 8 / 16	TJ	24Hr Tamper Z\$\$ Trouble Restore
25	24HrPanicZoneTrouble	1375	Zone 1 – 8 / 16	PT	24Hr Panic Z\$\$ Trouble
26	24HrPanicZoneTroubleRestore	3375	Zone 1 – 8 / 16	PJ	24Hr Panic Z\$\$ Trouble Restore
27	24HrHoldUpZoneTrouble	1376	Zone 1 – 8 / 16	HT	24Hr Hold-Up Z\$\$ Trouble
28	24HrHoldUpZoneTroubleRestore	3376	Zone 1 – 8 / 16	HJ	24Hr Hold-Up Z\$\$ Trouble Restore
29	24HrFireZoneTrouble	1373	Zone 1 – 8 / 16	FT	24Hr Fire Z\$\$ Trouble
30	24HrFireZoneTroubleRestore	3373	Zone 1 – 8 / 16	FJ	24Hr Fire Z\$\$ Trouble Restore
31	24HrBypass	1572	Zone 1 – 8 / 16	BB	24Hr Z\$\$ Bypass
32	24HrUnBypass	3572	Zone 1 – 8 / 16	BU	24Hr Z\$\$ UnBypass
33	24HrMedicalZoneBypass	1572	Zone 1 – 8 / 16	MB	24Hr Medical Z\$\$ Bypass
34	24HrMedicalZoneUnBypass	3572	Zone 1 – 8 / 16	MU	24Hr Medical Z\$\$ UnBypass
35	24HrTamperZoneBypass	1572	Zone 1 – 8 / 16	TB	24Hr Tamper Z\$\$ Bypass
36	24HrTamperZoneUnBypass	3572	Zone 1 – 8 / 16	TU	24Hr Tamper Z\$\$ UnBypass
37	24HrPanicZoneBypass	1572	Zone 1 – 8 / 16	PB	24Hr Panic Z\$\$ Bypass
38	24HrPanicZoneUnBypass	3572	Zone 1 – 8 / 16	PU	24Hr Panic Z\$\$ UnBypass
39	24HrHoldUpZoneBypass	1572	Zone 1 – 8 / 16	HB	24Hr Hold-Up Z\$\$ Bypass
40	24HrHoldUpZoneUnBypass	3572	Zone 1 – 8 / 16	HU	24Hr Hold-Up Z\$\$ UnBypass
41	24HrFireZoneBypass	1571	Zone 1 – 8 / 16	FB	24Hr Fire Z\$\$ Bypass
42	24HrFireZoneUnBypass	3571	Zone 1 – 8 / 16	FU	24Hr Fire Z\$\$ UnBypass
43	RFSensorMissing	1381	Zone 1 – 8 / 16	BZ	RF Sensor \$\$ Missing
44	RFSensorMissingRestore	3381	Zone 1 – 8 / 16	BR	RF Sensor \$\$ Missing Restore
45	RFFireSensorMissing	1381	Zone 1 – 8 / 16	FZ	RF Fire Sensor \$\$ Missing
46	RFFireSensorMissingRestore	3381	Zone 1 – 8 / 16	FR	RF Fire Sensor \$\$ Missing Restore
47	SensorWatchFail	1391	Zone 1 – 8 / 16	NA	Sensor \$\$ Watch Fail
48	SensorWatchFailRestore	3391	Zone 1 – 8 / 16	NS	Sensor \$\$ Watch Fail Restore
49	SensorTamper	1144	Zone 1 – 8 / 16	TA	Sensor \$\$ Tamper
50	SensorTamperRestore	3144	Zone 1 – 8 / 16	TR	Sensor \$\$ Tamper Restore
51	RFSensorLowBattery	1384	Zone 1 – 8 / 16	XT	RF Sensor \$\$ Low Battery
52	RFSensorLowBatteryRestore	3384	Zone 1 – 8 / 16	XR	RF Sensor \$\$ Battery Restore



Index	Event Description	CID Event Code	CID Point ID	SIA Event Code	String (Email / Codepad Display)
53	KeyfobLowBattery	1384	301 – 332	XT	Keyfob \$\$ Low Battery
54	KeyfobLowBatteryRestore	3384	301 – 332	XR	Keyfob \$\$ Battery Restore
55	Disarm	1401	User 1 – 32	OP	User\$\$\$/Installer/QuickArea\$ Disarm
56	AwayArm	3401	User 1 – 32	CL	User\$\$\$ /Quick/PowerUp Area\$ AWAY Arm
57	Stay1Arm	3441	User 1 – 32	NL	User\$\$\$ /A-Link/Quick/PowerUp Area \$ STAY1 Arm
58	Stay2Arm	3456	User 1 – 32	NM	A-Link/Quick/PowerUp Area\$ STAY2 Arm
59	KeyswitchDisarm	1409	Zone 1 – 8 / 16	OS	Keyswitch Zone\$\$ Area\$ Disarm
60	KeyswitchAwayArm	3409	Zone 1 – 8 / 16	CS	Keyswitch Zone\$\$ Area\$ AWAY Arm
61	KeyswitchStay1Arm	3442	Zone 1 – 8 / 16	NL	Keyswitch Zone\$\$ Area\$ STAY1 Arm
62	AutoDisarm	1403	997	OA	Schedule Area\$ Disarm
63	AutoAwayArm	3403	997	CA	Schedule Area\$ AWAY Arm
64	AutoStay1Arm	3403	997	NL	Schedule Area\$ STAY1 Arm
65	RemoteDisarm	1407	998	OQ	A-Link Area\$ Disarm
66	RemoteAwayArm	3407	995 ( Telephone ) ; 998 ( A-Link )	CQ	Telephone/A-Link Area\$ AWAY Arm
67	RemoteStay1Arm	3441	998	NL	A-Link Area\$ STAY1 Arm
68	RemoteStay2Arm	3456	998	NM	A-Link Area\$ STAY2 Arm
69	Duress	1121	User 1 – 32	HA	User\$\$\$ Duress Alarm
70	CodepadLocked (AccessDenied)	1461	881 – 884	JA	Codepad \$\$ Locked
71	KeyfobPanic	1120	301 – 332	PA	Keyfob \$\$ Panic
72	CodepadPanic	1120	881 – 884	PA	Codepad \$\$ Panic
73	CodepadMedical	1100	881 – 884	MA	Codepad \$\$ Medical
74	CodepadFire	1110	881 – 884	FA	Codepad \$\$ Fire
75	RFReceiverMissing	1333	821	EM	RF Receiver Missing
76	RFReceiverMissingRestore	3333	821	EN	RF Receiver Missing Restore
77	RFReceiverJamming	1344	821	XQ	RF Receiver Jamming
78	RFReceiverJammingRestore	3344	821	XH	RF Receiver Jamming Restore
79	RFReceiverTamper	1341	821	XS	RF Receiver Tamper

Index	Event Description	CID Event Code	CID Point ID	SIA Event Code	String (Email / Codepad Display)
80	RFReceiverTamperRestore	3341	821	XJ	RF Receiver Tamper Restore
81	RFRepeaterMissing	1333	821	EM	RF Repeater \$\$ Missing
82	RFRepeaterMissingRestore	3333	821	EN	RF Repeater \$\$ Missing Restore
83	RFRepeaterTamper	1341	821	XS	RF Repeater \$\$ Tamper
84	RFRepeaterTamperRestore	3341	821	XJ	RF Repeater \$\$ Tamper Restore
85	CodepadMissing	1333	881 – 884	EM	Codepad \$\$ Missing
86	CodepadMissingRestore	3333	881 – 884	EN	Codepad \$\$ Missing Restore
87	CodepadTamper	1341	881 – 884	ES	Codepad \$\$ Tamper
88	CodepadTamperRestore	3341	881 – 884	EJ	Codepad \$\$ Tamper Restore
89	IPModuleMissing	1333	871 – 872	EM	IP Module \$\$ Missing
90	IPModuleMissingRestore	3333	871 – 872	EN	IP Module \$\$ Missing Restore
91	IPModuleTamper	1341	871 – 872	ES	IP Module \$\$ Tamper
92	IPModuleTamperRestore	3341	871 – 872	EJ	IP Module \$\$ Tamper Restore
93	EXOutputMissing	1333	851 – 852	EM	Ex. Output \$\$ Missing
94	EXOutputMissingRestore	3333	851 – 852	EN	Ex. Output \$\$ Missing Restore
95	EXOutputTamper	1341	851 – 852	ES	Ex. Output \$\$ Tamper
96	EXOutputTamperRestore	3341	851 – 852	EJ	Ex. Output \$\$ Tamper Restore
97	PowerFail	1301	891	AT	AC Power Fail
98	PowerRestore	3301	891	AR	AC Power Restore
99	LowBattery	1302	891	YT	System Low Battery
100	BatteryRestore	3302	891	YR	System Battery Restore
101	AuxPowerFail	1312	891	YI	AUX Power Fail
102	AuxPowerFailRestore	3312	891	YJ	AUX Power Restore
103	PanelTamper	1341	891	ES	Panel Tamper
104	PanelTamperRestore	3341	891	EJp	Panel Tamper Restore
105	ProgramChange	1306	891	YG	Program Change
106	PhoneLineFail	1351	891	LT	Phone Line Fail
107	PhoneLineFailRestore	3351	891	LR	Phone Line Restore
108	OutputFail	1320	891	YA	Warning Device Fail
109	OutputFailRestore	3320	891	YH	Warning Device Restore
110	CommFail	1354	891	YC	Comm Fail
111	CommRestore	3354	891	YK	Comm Restore

Index	Event Description	CID Event Code	CID Point ID	SIA Event Code	String (Email / Codepad Display)
112	CommManualTest	1601	000	RX	Comm Manual Test
113	CommAutoTest	1602	000	RP	Comm Auto Test
114	DateTimeSet	1625	User 1 – 32; 998(A-Link)	JT	User\$\$\$ /A-Link Set Clock
115	WalkTestBegin	1607	000 ( Installer ) ; User 1 – 32	--	Walk Test Begin
116	WalkTestEnd	3607	000 ( Installer ) ; User 1 – 32	--	Walk Test End

Note: "\$" in the string will be replaced by matched number.

## 12 Access

This section describes the access codes used to assign privileges and access functions for User Code holders of the system. There are two types of access codes: the Installer Code and User Codes. Each of these codes allows specific access and operation of control panel functions.

### 12.1 Installer Code

Item	Location	Option	Default	New
Installer Code	0181		1	
	0182		2	
	0183		3	
	0184		4	

This code is used to access Installer's Programming Mode. The Installer Code can be up to four digits long. After the control panel is powered up, the Installer Code can disarm the system before any partition has arm/disarm operation. The next time the Installer Code is used enables access to Installer's Programming Mode.

Installer Code functions allow the installer to execute functions when the system is disarmed without the customer's Master Code.

#### See also

- *Installer Code Functions, page 39*
- *Installer Commands, page 24*

### 12.2 User Codes

Item	Location	Default	New	Authority Level Location	Default	New
User #01	0185	2		0189	10	
	0186	5				
	0187	8				
	0188	0				
User #02	0190 - 0193	15		0194	2	
User #03	0195 - 0198	15		0199	2	
User #04	0200 - 0203	15		0204	2	
User #05	0205 - 0208	15		0209	2	
User #06	0210 - 0213	15		0214	2	
User #07	0215 - 0218	15		0219	2	
User #08	0220	0		0224	3	
	0221 - 0223	15				
User #09	0225 - 0228	15		0229	2	
User #10	0230 - 0233	15		0234	2	
User #11	0235 - 0238	15		0239	2	

Item	Location	Default	New	Authority Level Location	Default	New
User #12	0240 - 0243	15		0244	2	
User #13	0245 - 0248	15		0249	2	
User #14	0250 - 0253	15		0254	2	
User #15	0255 - 0258	15		0259	2	
User #16	0260 - 0263	15		0264	2	
User #17	0566 - 0569	15		0570	2	
User #18	0571 - 0574	15		0575	2	
User #19	0576 - 0579	15		0580	2	
User #20	0581 - 0584	15		0585	2	
User #21	0586 - 0589	15		0590	2	
User #22	0591 - 0594	15		0595	2	
User #23	0596 - 0599	15		0600	2	
User #24	0601 - 0604	15		0605	2	
User #25	0606 - 0609	15		0610	2	
User #26	0611 - 0614	15		0615	2	
User #27	0616 - 0619	15		0620	2	
User #28	0621 - 0624	15		0625	2	
User #29	0626 - 0629	15		0630	2	
User #30	0631 - 0634	15		0635	2	
User #31	0636 - 0639	15		0640	2	
User #32	0641 - 0644	15		0645	2	

Authority Levels	Description
0	Arm/Disarm
1	Arm Only
2	Arm/Disarm and Arm/Disarm Reports
3	Arm Only and Arm Reports
4	Arm/Disarm and Code Required to Isolate
6	Arm/Disarm and Arm/Disarm Reports and Code Required to Isolate
8	Master Code and Arm/Disarm
10	Master Code and Arm/Disarm and Arm/Disarm Reports

Authority Levels	Description
12	Master Code and Arm/Disarm and Code Required to Isolate
14	Master Code and Arm/Disarm and Code Required to Isolate and Arm/Disarm Reports

**Table 12.1: Authority Levels**

The purpose of User Codes is to arm and disarm the system and to perform other specific functions. A Master Code holder can change or delete User Codes belongs to its partition at any time.

User Codes 1 to 32 can be one to four digits long, but all user codes should be the same length. Each User Code has its own priority level. More than one User Code can have the same priority level. The priority level controls the behavior of the code, such as allowing it to arm only, arm and disarm, or allow access to the Master Code functions. The installer can assign access to Master Code functions to multiple User Codes. The priority level for each User Code is programmed in the last location of the code.



**Notice!**

Only the installer can change the priority level.

There are 32 User Codes and 32 RF User Codes, RF User Codes can only be Remote Radio User Codes.

Special User Code is reported when any of these methods are used to arm or disarm the system:

- User Code 998: Arming and disarming using the A-Link Plus software.
- User Code 995: Arming remotely by telephone.
- User Code 000: Single button arming/disarming in AWAY Mode, STAY Mode 1, or STAY Mode 2.
- User Code 997: Automatic arming/disarming in AWAY Mode or STAY Mode 1.
- User Code 994: When Arm/Disarm Tracking on Power Up selected, if the system is armed when the system is powered down, the system returns to the armed state when the system is powered back up.
- User Code 999: After the control panel is powered up, if the installer code is the first code to use, the installer code can disarm the system before any partition has arm/disarm operation.

**See also**

- *Master Code Functions, page 47*
- *RF Keyfob Operations, page 56*

## 12.3

### User Code Priority

The installer can assign one of ten different priority levels to a User Code. Each priority level allows or restricts a user from performing specific functions.

**Arm/Disarm**

The user can arm and disarm the system. An Arming Report is sent only after a previous code with the ability to send a Disarming Report disarms the system.

**Arm Only**

The user can arm the system but cannot disarm the system. An Arming Report is sent only after a previous code with the ability to send a Disarming Report disarms the system.

#### Arming/Disarming Reports

Arming/Disarming Reports are sent to the monitoring station when the user disarms and arms the system.

#### Code To Isolate

If one or more User Codes include this option, the method of standard isolating is disabled and only a User Code with this option in its priority level can isolate zones before arming the system using the Code to Isolate method. Refer to *Isolating zones, page 34*.



#### Notice!

When priority level 4, 6, 12, or 14 is assigned to any User Codes, the Standard Isolating method no longer operates. Only User Codes with a priority level of 4, 6, 12, or 14 can isolate zones using the Code to Isolate method.

#### Master Code Functions

Master Code functions allow those users that have the appropriate priority level to perform certain supervisory level functions. You can use these functions only when the system is disarmed.



#### Notice!

The default Master Code (User Code 1) is 2580. It is possible to program multiple Master Codes

To access a Master Code function, enter the Master Code and press the corresponding function digit and the [AWAY] button. The Master Code functions are listed in below table.

Function	Description
0	Arm or disarm both areas at the same time
1	Add, change, and delete User Codes/Remote Radio User Codes
2	Change domestic phone numbers
3	Change Telco Arm/Disarm Sequence
4	Set bypass zones for STAY Mode 2
5	Turn outputs on and off
6	Set the date and time
7	Walk Test Mode
8	Event Memory Recall Mode
9989	System reset

**Table 12.2: Master Code Functions**

#### See also

- *Master Code Functions, page 47*

## 13 Zone Information

### 13.1 Day Alarm Information

Item	Location	Option	Default	New
Day Alarm Zones	0265	1 = Zone 1 2 = Zone 2 4 = Zone 3 8 = Zone 4	0	

This location has four programming options. You can select any combination of the options by programming a single value. Calculate this value by adding the option bit numbers together. Day Alarm allows some zones to be monitored when the system is disarmed. Indications are available at any of the programmable outputs, including the codepad buzzer. This function accommodates latching and non-latching Day Alarm Output Event Types.

When the system is armed in AWAY Mode, STAY Mode 1, or STAY Mode 2, zones programmed as Day Alarm Zones activate the sirens and report just as non-Day Alarm Zones do. When Day Alarm is activated, it ignores any zone Pulse Count settings programmed for that zone (that is, the zone Pulse Count is only relevant when the system is armed).

#### Example

You can set up a Day Alarm at the front door of a shop with a pressure mat or electronic beam that is activated when a customer enters the shop. When a customer walks on the pressure mat or breaks the electronic beam, the codepad buzzer beeps.

#### 13.1.1 Day Alarm Resetting

An output that is programmed for Day Alarm Resetting operates when a zone programmed for Day Alarm is activated. The output is reset after the zone is resealed. This occurs only when the system is disarmed. Refer to **0,14 Day Alarm Resetting** in *Output Event Types*, page 120 for more information.

#### 13.1.2 Day Alarm Latching

An output that is programmed for Day Alarm Latching operates when a zone programmed for Day Alarm is activated. The zone indicator and the latching output resets when [AWAY] is pressed. This occurs only when the system is disarmed. Refer to **0,15 Day Alarm Latching** in *Output Event Types*, page 120 for more information.

#### 13.1.3 Day Alarm Operation

If a zone is programmed for Day Alarm, the zone can be isolated in the normal way so that it does not register as a Day Alarm Zone when the system is disarmed. You can use only Zones 1 to 4 as Day Alarm Zones.

You can program the STAY indicator to indicate whether Day Alarm is turned on or off by selecting Option 8 in Location 496 (refer to *Consumer Options 1*, page 137). When Day Alarm is on, the STAY indicator flashes once every 3 seconds.

You can program an output to mimic a zone for monitoring Zones 5 to 8. Refer to *Output Event Types*, page 120.

#### To turn Day Alarm on:

Press and hold [4] until three beeps sound.

#### To turn Day Alarm off:

Press and hold [4] until two beeps sound.



## 13.2 EOL Resistor Value

Location 266	
0	No EOL
1	1K (brown, black, red)
2	1K5 (brown, green, red)
3	2K2 (red, red, red)
4	3K3 (orange, orange, black, brown) 1%
5	3K9 (orange, white, red)
6	4K7 (yellow, violet, red)
7	5K6 (green, blue, red)
8	6K8 (blue, grey, black, brown) 1%
9	10K (brown, black, orange)
10	12K (brown, red, orange)
11	22K (red, red, orange)
12	Reserved
13	Reserved
14	Split EOL (3K3/6K8) with tamper (1K)
15	Split EOL 1% resistors

You can program the control panel for different end-of-line (EOL) resistor values. This is a global parameter that affects all zones simultaneously. This feature allows you to install the control panel at an existing site without changing the EOL resistors. This feature also increases the security of the system because eleven possible EOL resistor values can be used, which makes it extremely difficult to tamper with the system.

For No EOL, it is short as normal status and it is unsealed when the system activates an alarm.

### Connections for EOL Resistors

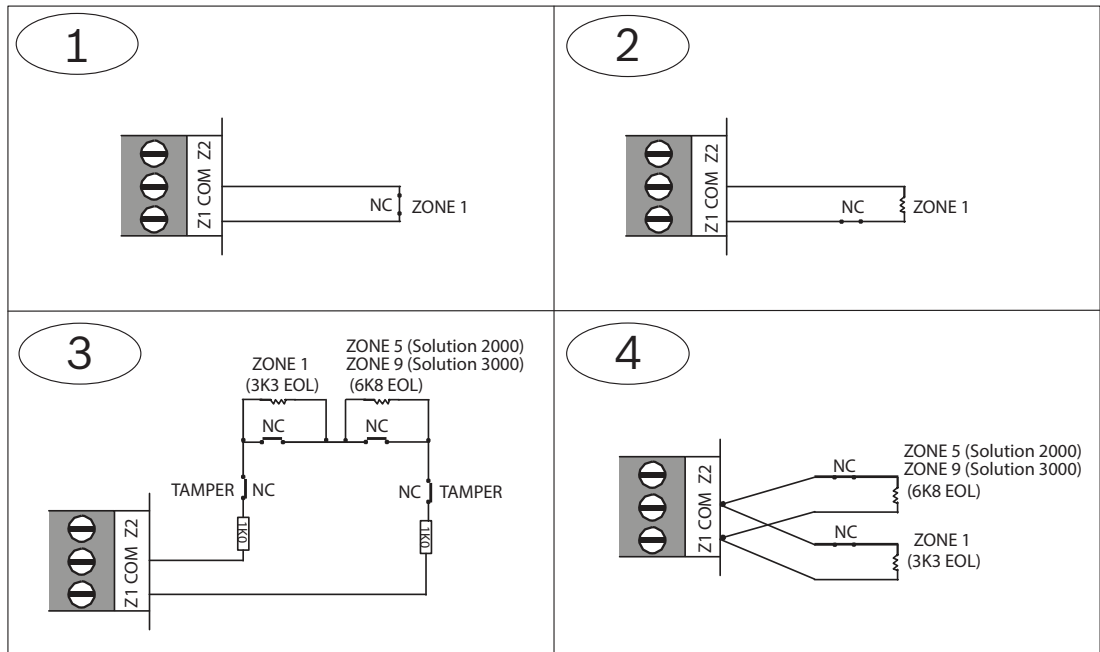

Callout - Description
1 – Zone without resistor (Location 266 = 0 (No EOL))
2 – Single Zone input (Location 266 = 1k, 1k5, 2k2, 3k3, 3k9, 4k7, 5k6, 6k8, 10k, 12k, 22k)
3 – Double Zone with tamper (Location 266 = 14 (Split EOL3K3 / 6K8 with tamper))
4 – Double Zone input (Location 266 = 15 (Split EOL 3k3 / 6k8))

### 13.3 Zone Programming

The programming information for each zone is stored in six locations divided into three groups. The first three locations determine how the zone operates, the next two locations set up a number of zone options, and the last location stores the communicator reporting information for the zone.

#### Zone Operating Information

These locations store the Zone Type (for example, Delay-1, Instant, or 24-Hour), the Zone Pulse Count, and the Zone Pulse Count Time. The Zone Pulse Count specifies the number of times the zone must activate within the time specified in the Zone Pulse Count Time. Refer to *Zone Types*, page 94, *Zone Pulse Count*, page 96, and *Zone Pulse Count Time*, page 97 for more information.

#### Zone Options

These two locations allow you to select from a number of options. Refer to *Zone Options 1*, page 97 and *Zone Options 2*, page 98 for more information.

#### Zone Reporting Information

This information includes the locations for the Zone Report Options. The Zone Report Options location enables you to specify how a zone reports to a base station receiver. Refer to *Zone Report Options*, page 99 for more information.

#### 13.3.1 Zone Defaults

You can program Zones 1 to 16 as any zone type.

<b>Location 267 to 378</b>		
	<b>Location</b>	<b>Default</b>
<b>Zone #01 (Default = Delay-1)</b>		
Zone Type	267	2
Zone Pulse Count	268	0
Zone Pulse Count Time	269	0
Zone Options 1	270	1
Zone Options 2	271	14
Zone Report Options	273	1
<b>Zone #02 (Default = Handover)</b>		
Zone Type	274	1
Zone Pulse Count	275	0
Zone Pulse Count Time	276	0
Zone Options 1	277	1
Zone Options 2	278	14
Zone Report Options	280	1
<b>Zone #03 (Default = Handover)</b>		
Zone Type	281	1
Zone Pulse Count	282	0
Zone Pulse Count Time	283	0
Zone Options 1	284	1
Zone Options 2	285	14
Zone Report Options	287	1
<b>Zone #04 (Default = Handover)</b>		
Zone Type	288	1
Zone Pulse Count	289	0
Zone Pulse Count Time	290	0
Zone Options 1	291	1
Zone Options 2	292	14
Zone Report Options	294	1
<b>Zone #05 (Default = Instant)</b>		
Zone Type	295	0
Zone Pulse Count	296	0

<b>Location 267 to 378</b>		
	<b>Location</b>	<b>Default</b>
Zone Pulse Count Time	297	0
Zone Options 1	298	1
Zone Options 2	299	14
Zone Report Options	301	1
<b>Zone #06 (Default = Instant)</b>		
Zone Type	302	0
Zone Pulse Count	303	0
Zone Pulse Count Time	304	0
Zone Options 1	305	1
Zone Options 2	306	14
Zone Report Options	308	1
<b>Zone #07 (Default = Instant)</b>		
Zone Type	309	0
Zone Pulse Count	310	0
Zone Pulse Count Time	311	0
Zone Options 1	312	1
Zone Options 2	313	12
Zone Report Options	315	1
<b>Zone #08 (Default = 24-hr Tamper)</b>		
Zone Type	316	9
Zone Pulse Count	317	0
Zone Pulse Count Time	318	0
Zone Options 1	319	1
Zone Options 2	320	12
Zone Report Options	322	1
<b>Zone #09 (Default = Not used)</b>		
Zone Type	323	15
Zone Pulse Count	324	0
Zone Pulse Count Time	325	0
Zone Options 1	326	1
Zone Options 2	327	14
Zone Report Options	329	1

<b>Location 267 to 378</b>		
	<b>Location</b>	<b>Default</b>
<b>Zone #10 (Default = Not used)</b>		
Zone Type	330	15
Zone Pulse Count	331	0
Zone Pulse Count Time	332	0
Zone Options 1	333	1
Zone Options 2	334	14
Zone Report Options	336	1
<b>Zone #11 (Default = Not used)</b>		
Zone Type	337	15
Zone Pulse Count	338	0
Zone Pulse Count Time	339	0
Zone Options 1	340	1
Zone Options 2	341	14
Zone Report Options	343	1
<b>Zone #12 (Default = Not used)</b>		
Zone Type	344	15
Zone Pulse Count	345	0
Zone Pulse Count Time	346	0
Zone Options 1	347	1
Zone Options 2	348	14
Zone Report Options	350	1
<b>Zone #13 (Default = Not used)</b>		
Zone Type	351	15
Zone Pulse Count	352	0
Zone Pulse Count Time	353	0
Zone Options 1	354	1
Zone Options 2	355	14
Zone Report Options	357	1
<b>Zone #14 (Default = Not used)</b>		
Zone Type	358	15
Zone Pulse Count	359	0
Zone Pulse Count Time	360	0

<b>Location 267 to 378</b>		
	<b>Location</b>	<b>Default</b>
Zone Options 1	361	1
Zone Options 2	362	14
Zone Report Options	364	1
<b>Zone #15 (Default = Not used)</b>		
Zone Type	365	15
Zone Pulse Count	366	0
Zone Pulse Count Time	367	0
Zone Options 1	368	1
Zone Options 2	369	14
Zone Report Options	371	1
<b>Zone #16 (Default = Not used)</b>		
Zone Type	372	15
Zone Pulse Count	373	0
Zone Pulse Count Time	374	0
Zone Options 1	375	1
Zone Options 2	376	14
Zone Report Options	378	1

The Solution 2000 control panel supports up to 8 zones. The Solution 3000 control panel supports up to 16 zones. Zone 9-16 can only be used in Solution 3000 control panels when the EOL Resistor Value is set as 14 or 15.

### 13.3.2

#### Zone Types

The zone types are listed in the table below.

<b>Zone Type</b>	<b>Description</b>
0	Instant
1	Handover
2	Delay-1
3	Delay-2
4	Reserved
5	Reserved
6	24-Hour Medical
7	24-Hour Panic
8	24-Hour Holdup

Zone Type	Description
9	24-Hour Tamper
10	Reserverd
11	Keyswitch
12	24-Hour Burglary
13	24-Hour Fire
14	Chime Only
15	Not Used

### 0 – Instant Zone

When the Country Code is set as Australia (refer to *Country Codes, page 70*), an Instant Zone (Contact ID Event Code 130) immediately sounds the sirens and sends the zone alarm reports if it is unsealed after the Exit Timer expires.

Arming Report is sent after the Exit Timer expires.

If an Instant Zone is not restored when the time the system is disarmed, a Zone Restore Report is automatically sent to the receiving party.

### 1 – Handover Zone

A Handover Zone (Contact ID Event Code 130) acts as an Instant Zone if it is activated by itself. If a Handover Zone is activated after a Delay Zone, the remaining Delay Time is handed over from the Delay Zone to the Handover Zone.

Handover can be sequential or non-sequential. The default settings is sequential handover. You can disable sequential handover by disabling Option 8 in Location 494 (refer to *System Options 3, page 135*).

Handover Zone is not restored when the system is disarmed, a Zone Restore Report is automatically sent to the receiving party.

### 2 – Delay-1 Zone

A Delay-1 Zone (Contact ID Event Code 130) has a delay time determined by the value in Locations 466 and 467 (refer to *Entry Time 1, page 130*). After Entry Time expires, the system activates an alarm.

If a Delay-1 Zone is not restored when the system is disarmed, a Zone Restore Report is automatically sent to the receiving party.

### 3 – Delay-2 Zone

A Delay-2 Zone (Contact ID Event Code 130) has a delay time determined by the value in Locations 468 and 469 (refer to *Entry Time 2, page 130*). After Entry Time expires, the system activates an alarm.

If a Delay-2 Zone is not restored when the system is disarmed, a Zone Restore Report is automatically sent to the receiving party.

### 6 – 24-Hour Medical Zone

A 24-Hour Medical Zone (Contact ID Event Code 100) is always ready to activate the horn speaker, bell, and strobe, whether the system is armed or disarmed. A Medical Report is transmitted to the base station receiver. A 24-Hour Medical Zone does not send a Restore Report until the zone is restored.

### 7 – 24-Hour Panic Zone

A 24-Hour Panic Zone (Contact ID Event Code 120) is always ready to activate the horn speaker, bell, and strobe, whether the system is armed or disarmed. A Panic Report is transmitted to the base station receiver. A 24-Hour Panic Zone does not send a Restore Report until the zone is restored.

#### **8 – 24-Hour Holdup Zone**

A 24-Hour Holdup Zone (Contact ID Event Code 122) is always ready to activate the horn speaker, bell, and strobe, whether the system is armed or disarmed. If you want the holdup alarm to be silent, select Option 4 in the first Zone Options location (refer to *Zone Options 1*, page 97). A 24-Hour Holdup Zone does not send a Restore Report until the zone is restored.

#### **9 – 24-Hour Tamper Zone**

A 24-Hour Tamper Zone (Contact ID Event Code 137) is always ready to activate the horn speaker, bell, and strobe, whether the system is armed or disarmed. A 24-Hour Tamper zone does not send a Restore Report until the zone is restored.

#### **11 – Keyswitch Zone**

Use a Keyswitch Zone to connect a keyswitch to operate the system. The zone number is reported as a User Code when arming and disarming using this method of operation, refer to *Keyswitch Zone Options*, page 100 for more information. (Contact ID Event Code 409 for Keyswitch Away Arm and Keyswitch Disarm, 442 for Keyswitch Stay 1 Arm).

#### **12 – 24-Hour Burglary Zone**

A 24-Hour Burglary Zone (Contact ID Event Code 133) is always ready to activate the horn speaker, bell, and strobe, whether the system is armed or disarmed. A 24-Hour Burglary zone does not send a Restore Report until the zone is restored.

#### **13 – 24-Hour Fire Zone**

A 24-Hour Fire Zone (Contact ID Event Code 110) is always ready to activate the horn speaker, bell, and strobe, whether the system is armed or disarmed. A distinct fire sound is emitted through the horn speaker to indicate this type of alarm. This fire sound is completely different from the burglary sound. A 24-Hour Fire zone does not send a Restore Report until the zone is restored.

#### **14 – Chime Zone**

A Chime Zone is not a burglary zone. It can never sound the sirens or transmit reports. Its purpose is to map the zone to a programmable output (refer to 4,5 Global Chime in *Output Event Types*, page 120) to indicate if the zone is sealed or unsealed.

Chime zones require EOL resistors and are registered at a codepad. These zones do not affect the operation of forced arming.

#### **15 – Zone Not Used**

If a zone is not used, program the zone type location to 15. An EOL resistor is not required if this zone type is used. This zone type never sounds the sirens or transmits the reports.

### **13.3.3**

#### **Zone Pulse Count**

Zone pulse count is the number of times a zone must be activated before the zone registers an alarm. The number can vary from 0 to 15. The zone pulse count value is relative to the time frame (that is, the number of pulses that must be present during a particular time frame). Zone Pulse Count = 0, means the Zone Pulse Count function is disabled. Refer to *Zone Pulse Count Time*, page 97 for more information.



#### **Notice!**

A zone that is programmed with a pulse count activates an alarm when it is continuously unsealed for 10 sec. A 24-Hour Fire Zone programmed with a pulse count activates an alarm when it is continuously unsealed for 30 sec.



**Zone Pulse Count Handover**

Zone pulse count handover operates only with Zone Pulse Count Time options 8 to 15. Any zone that registers one active pulse automatically increments any other zone pulse count that already registered at least one activate pulse during its respective time. To enable this feature, select Option 4 in Location 494 (refer to *System Options 3, page 135*).

**Notice!**

24-Hour Zones cannot receive any handover pulses from other zones. 24-Hour Zones can handover pulses to other zones.

**13.3.4****Zone Pulse Count Time**

Zone pulse count time is the time frame or period over which the programmed number of pulses must register to activate an alarm.

<b>20 ms Option</b>	<b>Loop Response Time (sec)</b>	<b>150 ms Option</b>	<b>Loop Response Time (sec)</b>
0	0.5	8	20
1	1	9	30
2	2	10	40
3	3	11	50
4	4	12	60
5	5	13	90
6	10	14	120
7	15	15	200

**Table 13.1: Zone Pulse Count Times**

For zone pulse count time, options 0 to 7 have a zone loop response time of 20 ms and options 8 to 15 have a zone loop response time of 150 ms. Loop response time is the length of time a zone must be unsealed before it can register as a valid pulse.

Inertia sensors should use options 0 to 7 and PIR detectors should use options 8 to 15.

**13.3.5****Zone Options 1**

This location has four programming options. You can select any combination of the options by programming a single value. Calculate this value by adding the option bit numbers together.

<b>Option</b>	<b>Description</b>
1	Lockout Siren/Lockout Report
2	Delay Alarm reporting
4	Silent Alarm
8	Sensor Watch

**1 – Lockout Siren and Lockout Report**

Lockout refers to certain activations per arming cycle (that is, a zone programmed for Lockout can activate the sirens or communication module for certain times as programmed).

The next time the system is armed, the zone can activate the sirens and reports once more. Restore signals are sent when the system is disarmed.

Lockout Siren and Lockout Report are separate for each zone. If a zone's siren or report is locked out, the other zone's siren or report still can be activated.

Use Location 379 to set the number of times the siren is allowed to activate before it is locked out (refer to *Swinger Shutdown Count for Siren, page 101*).

Use Location 380 to set the number of times the communication module is activated to send reports before lockout takes effect (refer to *Swinger Shutdown Count for Report, page 102*).

Use Location 492 to resend the Zone Reports when the report is unlocked out as Smart Lockout Allowed in *System Options 1, page 134*.

When the smart lockout is allowed, the Lockout Report becomes unlocked and sends Alarm Reports if the locked zone is activated again before the Siren Running Time (refer to *Siren Run Time, page 132a*) is expired and if any other zone is activated

#### **2 – Delay Alarm Reporting**

Select this option to allow the reporting of alarms on selected zones to be delayed so that a user can enter a code to cancel alarms that are not required to report. All sounding devices (horn speaker, strobe, and bell outputs) operate as soon as the alarm occurs, but the communication module does not operate until the delay time programmed in Locations 474 and 475 expires (refer to *Delay Alarm Reporting Time, page 131*).

During the same arming cycle, only the first Zone Alarm Report can be delayed.

#### **4 – Silent Alarm**

Select this option to program a zone as silent. A silent zone does not activate the horn speaker, bell, or strobe outputs. It activates the Silent Alarm output. The report and all other programmable outputs function according to the parameters programmed for the zone.

#### **8 – Sensor Watch**

Sensor watch allows the control panel to recognize when detection devices might have stopped working. This feature monitors the operation of a zone over the time period programmed in Locations 476 and 477 (refer to *Sensor Watch Time, page 131*).

This value specifies how many 24-hour periods a zone can remain continuously sealed before it registers as a Sensor Watch fault. The number of hours required to fulfill these 24-hour periods is calculated only when the system is disarmed. Every time the system is armed in the AWAY Mode, STAY Mode 1, or STAY Mode 2, the Sensor Watch Timer pauses its count. The Sensor Watch Timer continues its count the next time the system is disarmed.

#### **Example**

If the Sensor Watch Time is programmed for 2 days and the premises is armed for 12 hours and disarmed for 12 hours each day, it takes 4 days before a zone can register a Sensor Watch fault.

### **13.3.6**

#### **Zone Options 2**

This location has four programming options. You can select any combination of the options by programming a single value. Calculate this value by adding the option bit numbers together.

<b>Option</b>	<b>Description</b>
1	Isolate in STAY Mode 1
2	Zone Isolation Allowed

Option	Description
4	Forced Arming Allowed
8	Zone Restore Report

### 1 – Isolate in STAY Mode 1

If this option is selected, the zone can be automatically isolated when the system is armed in STAY Mode 1.

If this option is not selected and the system is armed in STAY Mode 1, the zone activates an alarm when activated as it normally would in AWAY Mode.

You can specify a global entry time for all zones, except for 24-Hour Zones, when the system is armed in STAY Mode 1. You program this time in Locations 472 and 473 (refer to *Entry Guard Time for STAY Mode*, page 131). The Entry Guard Timer overrides the delay time programmed for a Delay Zone. If you program the Entry Guard Timer as 0, each zone acts according to its programmed zone type.

Refer to *Arming the System in STAY Mode 1*, page 31 for more information.

### 2 – Zone Isolation Allowed

If this option is selected, the operator can isolate the zone before arming the system. If this option is not selected, the zone cannot be manually isolated. When a zone is manually isolated, a Zone Bypass Report (Contact ID Event Code 573) is sent. Refer to *Isolating zones*, page 34 for more information.

When a zone is automatically isolated in STAY Mode, a Zone Bypass Report is not sent.

When isolating 24-Hour Zones, the system automatically sends a Zone Bypass Report when the zone is selected to be isolated. All non-24-Hour zones send a Bypass Report only when the system is armed.

### 4 – Forced Arming Allowed

If this option is selected, the system can be armed with the zone unsealed. If this option is not selected, the system does not allow the User Code holder to arm the system until the zone is sealed or manually isolated. Refer to *Isolating zones*, page 34 for more information.

### 8 – Zone Restore Report

If this option is selected, the zone sends Restore Reports when the zone is restored. If this option is not selected, the zone does not send Restore Reports when the zone is restored.

If a non-24-Hour zone is not restored when the system is disarmed, the system automatically sends a Zone Restore Report for that zone. All 24-Hour zones send a Zone Restore Report only when the zone is restored.

## 13.3.7

### Zone Report Options

By default, a zone reports only to Receiver 1. The table below lists the reporting options for the zone.

Option	Description
0	No report required
1	Receiver 1
2	Receiver 2
4	Receiver 1 and Receiver 2
8	Receiver 2 only when Receiver 1 fails

### 13.3.8 Keyswitch Zone Options

The table below lists the options available to Keyswitch Zones. If you program a zone as a keyswitch input (Zone Type 11), program the selected Keyswitch Zone options in the location normally used for Zone Options 1.

Option	Description
0	Latching arm and disarm in AWAY Mode
1	Latching arm in AWAY Mode
2	Latching disarm from AWAY Mode, STAY Mode1, or STAY Mode 2
4	Latching arm and disarm in STAY Mode 1
5	Latching arm in STAY Mode 1
6	Latching disarm from STAY Mode 1 or STAY Mode 2
8	Momentary arm and disarm in AWAY Mode
9	Momentary arm in AWAY Mode
10	Momentary disarm from AWAY Mode, STAY Mode1, or STAY Mode 2
12	Momentary arm and disarm in STAY Mode 1
13	Momentary arm in STAY Mode 1
14	Momentary disarm from STAY Mode 1 or STAY Mode 2

#### **0 – Latching Arm and Disarm in AWAY Mode**

The system is armed or disarmed from AWAY Mode when using the latching keyswitch input.

#### **1 – Latching Arm in AWAY Mode**

The system is armed in AWAY Mode when using the latching keyswitch input. Disarming the system is not permitted from the Keyswitch Zone.

#### **2 – Latching Disarm from AWAY Mode, STAY Mode1, or STAY Mode 2**

The system is disarmed from AWAY Mode, STAY Mode 1, or STAY Mode 2 when using the latching keyswitch input. Arming the system is not permitted from the Keyswitch Zone.

#### **4 – Latching Arm and Disarm in STAY Mode 1**

The system is armed or disarmed in STAY Mode 1 when using the latching keyswitch input. Arming and disarming the system in AWAY Mode is not permitted from the Keyswitch Zone.

#### **5 – Latching Arm in STAY Mode 1**

The system is armed in STAY Mode 1 when using the latching keyswitch input. Arming the system in AWAY Mode or disarming the system is not permitted from the Keyswitch Zone.

#### **6 – Latching Disarm from STAY Mode 1 or STAY Mode 2**

The system is disarmed from STAY Mode 1 or STAY Mode 2 when using the latching keyswitch input. Arming the system in STAY Mode 1 or STAY Mode 2, or arming and disarming the system in AWAY Mode is not permitted from the Keyswitch Zone.

#### **8 – Momentary Arm and Disarm in AWAY Mode**

The system is armed or disarmed from AWAY Mode when using the momentary keyswitch input.

#### **9 – Momentary Arm in AWAY Mode**

The system is armed in AWAY Mode when using the momentary keyswitch input. Disarming the system is not permitted from the Keyswitch Zone.

**10 – Momentary Disarm from AWAY Mode, STAY Mode 1, or STAY Mode 2**

The system is disarmed from either AWAY Mode, STAY Mode 1, or STAY Mode 2 when using the momentary keyswitch input. Arming the system is not permitted from the Keyswitch Zone.

**12 – Momentary Arm and Disarm in STAY Mode 1**

The system is armed or disarmed in STAY Mode 1 when using the momentary keyswitch input. Arming and disarming the system in AWAY Mode is not permitted from the Keyswitch Zone.

**13 – Momentary Arm in STAY Mode 1**

The system is armed in STAY Mode 1 when using the momentary keyswitch input. Arming the system in AWAY Mode or disarming the system is not permitted from the Keyswitch Zone.

**14 – Momentary Disarm from STAY Mode 1 or STAY Mode 2**

The system is disarmed from STAY Mode 1 or STAY Mode 2 when using the momentary keyswitch input. Arming the system in STAY Mode 1 or STAY Mode 2, or arming and disarming the system from AWAY Mode is not permitted from the Keyswitch Zone.

Wiring Diagram for Keyswitch Zone	Wiring Diagram for Keyswitch Zone Using Split EOL with Tamper
	
<p>1 – EOL 2 – Keyswitch (Momentary/Toggle)</p>	<p>1 – EOL 2 – Keyswitch (Momentary/Toggle)</p>

Table 13.2: Wiring Diagram for Keyswitch Zone

### 13.4 Swinger Shutdown Count for Siren

Item	Location	Option	Default	New
Swinger Shutdown Count For Siren	0379	1 – 15 = Number of times siren operates until lockout	3	

Location 379 determines the number of times the sirens can be activated before lockout options take effect. This location has no effect unless you program at least one zone for lockout siren. Refer to *Zone Options 1*, page 97 for more information.

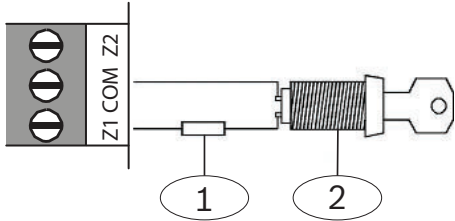
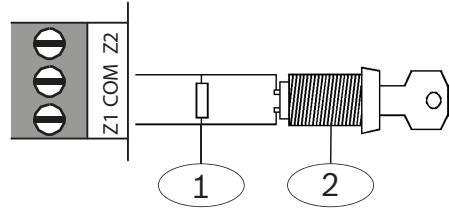
Only alarms activated from zone inputs can increment the Swinger Shutdown Counter. Alarms such as Codepad Panic, Access Denied, and other system alarms do not affect the Swinger Shutdown Count.

Lockout Siren is separate for each zone, If a zone's siren is locked out, another zone's siren can still be activated.

**Example**

Zone1 and 2 are programmed for Lockout Siren with a Swinger Shutdown Count of 2. If Zone 1 activates an alarm, the Swinger Shutdown Count is incremented by one after the end of Siren Run Time from 0 to a swinger shutdown count of 1.

After the Siren Run Time is reset from the previous alarm, Zone 2 activates an alarm and activates the sirens. After the sirens are reset, the swinger shutdown count for Zone 2 is incremented to 1 and the swinger shutdown count for Zone1 is still 1.

If Zone 1 activates an alarm again after the sirens are reset from Zone 2, the Swinger Shutdown Count for Zone 1 is incremented to 2, which locks out Zone 1 only from sounding the sirens until the system is reset, armed or disarmed.

At this point, Zone 1's Swinger Shutdown Count for Sirens is reset to 0.

## 13.5 Swinger Shutdown Count for Report

Item	Location	Option	Default	New
Swinger Shutdown Count For Report	0380	1 – 15 = Number of times report operates until lockout	6	

Location 380 determines the number of times the zone alarm report can be activated before lockout options take effect. This location has no effect unless you program at least one zone for lockout report. Refer to *Zone Options 1*, page 97 for more information.

Only alarms activated from zone inputs can increment the Swinger Shutdown Counter. Alarms such as Codepad Panic, Code Retries, and other system alarms do not affect the Swinger Shutdown Count.

Lockout Report is separate for each zone. If a zone's report is locked out, another zone's report can still be activated. Each zone has a standalone Swinger Shutdown Count for Report. This counter increases by 1 when a zone reports a new alarm or tamper event.

Use Location 492 to set smart lockout. When a zone report is locked out, if smart lockout is enabled, lockout events on this zone are not reported if no alarm is sounding. If an alarm is ongoing, events are reported as configured.



### Notice!

If Lockout Report is enabled for any zone, the last restore signal is not transmitted until the system is disarmed.

### Example

Zones 1 and 2 are programmed for lockout report with a Swinger Shutdown Count of 6. If Zone 1 activates an alarm, the Swinger Shutdown Count increments to 1 when the control panel sends the report.

If Zone 1 reactivates the report, the Swinger Shutdown Count is incremented to 2. If Zone 1 reactivates the report three more times, the Swinger Shutdown Count is 5.

If Zone 2 activates an alarm, the Swinger Shutdown Count for Zone 2 is incremented to 1. Swinger Shutdown Count for Zone 1 is still 5. If Zone 1 reactivates again, it locks out Zone 1 from activating the report. When smart lockout is enabled, if any zone activates the siren before siren running time is expired, Zone 1 reactivates and can still send a report.

## 13.6 STAY Mode 2 Automatically Bypass Zones

STAY Mode 2 Automatically Bypass Zones can be programmed in Location 381 - 384. It can also be done by master code function. Refer to *Setting STAY Mode 2 Bypass Zones*, page 45 for more information.

Zone 9 – 16 is only for Solution 3000.

Item	Location	Option	Default	New	
STAY Mode 2 Automatically Bypass Zones	0381	1 = Zone 1 2 = Zone 2	4 = Zone 3 8 = Zone 4	0	
	0382	1 = Zone 5 2 = Zone 6	4 = Zone 7 8 = Zone 8	0	

Item	Location	Option	Default	New	
	0383	1 = Zone 9 2 = Zone 10	4 = Zone 11 8 = Zone 12	0	
	0384	1 = Zone 13 2 = Zone 14	4 = Zone 15 8 = Zone 16	0	

### 13.7 Zone Status Reporting Options

Item	Location	Option	Default	New
Zone Status Reporting Options	0392	0 = No Zone status reports allowed 1 = Report to Receiver 1 2 = Report to Receiver 2 4 = Report to both Receiver 1 and Receiver 2 8 = Report to Receiver 2 only Receiver 1 fails	1	

This location is set by default to report only to Receiver 1. You can select whether Zone Status Reports are sent to Receiver 1, Receiver 2, or both, Receiver 2 only when Receiver 1 fails, or no reporting.

## 14 RF Information

In this section, RF Supervision Time, RADION Anti-Jamming Sensitivity, and RF Options are only for Solution 3000 control panel.

To use the RF function, you need to select RF receiver in location 395, program other RF parameters in this section, and add RF devices, RF keyfobs and RF repeaters.

### See also

- *WE800EV2 receiver, page 17*
- *HCT-4 keyfob, page 18*
- *RADION receiver B810, page 18*
- *RADION keyfobs, page 18*
- *RADION repeater, page 19*
- *RADION detectors, page 19*
- *Add or Delete RF Wireless Devices, page 39*
- *Adding Remote Radio User Codes, page 49*
- *Deleting User/Radio Codes , page 50*

### 14.1 RF Supervision Time

Item	Location	Option	Default	New	
RF Supervision Time (Only for Solution 3000 )	0393	0 = Disable 2 = 2 hours 3 = 4 hours 4 = 12 hours	5 = 24 hours 6 = 48 hours 7 = 72 hours	0	

An RF Supervision Failure Report (Contact ID Event Code 381) is sent to the base station receiver when the wireless receiver has not received a signal from any RF wireless zone during the RF Supervision Time. This report continues to be sent (according to the frequency of the RF Supervision Time) until the fault is corrected.

To clear the fault and stop additional reporting: Unseal and reseal the zone that registered the fault.



#### Notice!

If RF Supervision Failure Reports are not required, program Location 393 as 0.

### 14.2 Anti-Jamming Sensitivity

Item	Location	Option	Default	New
RADION Anti-Jamming Sensitivity (Only for Solution 3000 )	0394	0 = Most Sensitive 15 = Least Sensitive	12	

This parameter is only for Solution 3000 . It configures the anti-jamming sensitivity on the RADION receiver.

The RADION receiver will continually monitor the jamming status of every system transmitter to ensure reliable system communications.



## 14.3 RF Receiver

Item	Location	Option	Default	New
RF Receiver	0395	0 = Not used 1 = Use RADION receiver B810 2 = Use WE800EV2	0	

Solution 2000 control panel does not support RADION receiver.

Solution 3000 control panel supports both RADION and WE800EV2 receivers, but only one receiver can be used in one system.

## 14.4 RF Options

Item	Location	Option	Default	New
RF Options (Only for Solution 3000 )	0396	1 = Siren Sound On RF Receiver Fail 2 = RF Receiver Jam/Tamper Siren Alarm 4 = Unseal Zone That Fail Monitor	0	

### 1 – Sound Siren on RF Receiver Fail

If this option is selected, the horn speaker, piezo, and strobe operate when the RF receiver fails to communicate with the control panel.

### 2 – Sound Siren on RF Tamper/Jamming

If this option is selected, the horn speaker, piezo, and strobe operate when the tamper switch on the receiver becomes open circuit or the receiver picks up jamming signals from an RF device.

### 4 – Unseal Zone that Fails Supervision

If a wireless zone device fails to send a signal within the RF Supervision Time programmed in Location393, the codepad zone indicator lights as unsealed.

## 14.5 RFID

### RF keyfob RFID

Locations 1500 to 1817 are for RF keyfob IDs. RFID is a 9-digit numbers you can find on the keyfob. Control panel stores eight digits for each keyfob ID. Last digit of keyfob ID is a checksum.

### RF device RFID

Locations 1820 to 1978 are for RF Zone (device) IDs and the RF zone input options. Locations for the input have up to 4 options per location available for programming. You can select any combination of the options by programming a single value. But if you select Option 0 , all inputs are used as Option 15. Each wireless device contains corresponding input functions. Verify each zone device for input numbers, their sequence and how many inputs are enabled to check if the option you choose can be matched. Each device must have at least one valid input function selected.

### Example:

For RADION universal transmitter RFUN with two alarm inputs, program RF zone input options as below:

Option 1 = Input 1, only enable magnetic contact is selected;

Option 2 = Input 2, only external loop is selected;

Option 3 = Input 1 + Input 2, both alarm inputs (magnetic contact and external loop are selected).

#### RF repeater RFID

Locations 1980 to 2057 are for RF repeater IDs. RF device and repeater RFID are only for Solution 3000 .

### 14.5.1 RF Keyfob RFID

Item	Location	Default	New	Item	Location	Default	New
Keyfob #01	1500 - 1507	0		Keyfob #02	1510 - 1517	0	
Keyfob #03	1520 - 1527	0		Keyfob #04	1530 - 1537	0	
Keyfob #05	1540 - 1547	0		Keyfob #06	1550 - 1557	0	
Keyfob #07	1560 - 1567	0		Keyfob #08	1570 - 1577	0	
Keyfob #09	1580 - 1587	0		Keyfob #10	1590 - 1597	0	
Keyfob #11	1600 - 1607	0		Keyfob #12	1610 - 1617	0	
Keyfob #13	1620 - 1627	0		Keyfob #14	1630 - 1637	0	
Keyfob #15	1640 - 1647	0		Keyfob #16	1650 - 1657	0	
Keyfob #17	1660 - 1667	0		Keyfob #18	1670 - 1677	0	
Keyfob #19	1680 - 1687	0		Keyfob #20	1690 - 1697	0	
Keyfob #21	1700 - 1707	0		Keyfob #22	1710 - 1717	0	
Keyfob #23	1720 - 1727	0		Keyfob #24	1730 - 1737	0	
Keyfob #25	1740 - 1747	0		Keyfob #26	1750 - 1757	0	
Keyfob #27	1760 - 1767	0		Keyfob #28	1770 - 1777	0	
Keyfob #29	1780 - 1787	0		Keyfob #30	1790 - 1797	0	
Keyfob #31	1800 - 1807	0		Keyfob #32	1810 - 1817	0	

### 14.5.2 RF Device RFID

Item	Location	Default	New	RF Zone Option Location	Default	New
RF Zone #01	1820 - 1827	0		1828	0	
RF Zone #02	1830 - 1837	0		1838	0	
RF Zone #03	1840 - 1847	0		1848	0	
RF Zone #04	1850 - 1857	0		1858	0	
RF Zone #05	1860 - 1867	0		1868	0	
RF Zone #06	1870 - 1877	0		1878	0	
RF Zone #07	1880 - 1887	0		1888	0	
RF Zone #08	1890 - 1897	0		1898	0	
RF Zone #09	1900 - 1907	0		1908	0	

Item	Location	Default	New	RF Zone Option Location	Default	New
RF Zone #10	1910 - 1917	0		1918	0	
RF Zone #11	1920 - 1927	0		1928	0	
RF Zone #12	1930 - 1937	0		1938	0	
RF Zone #13	1940 - 1947	0		1948	0	
RF Zone #14	1950 - 1957	0		1958	0	
RF Zone #15	1960 - 1967	0		1968	0	
RF Zone #16	1970 - 1977	0		1978	0	

Item	Option		
RF Zone Option	0 = All Used	1 = Input 1 2 = Input 2	4 = Input 3 8 = Input 4

Table 14.1: RF Zone Options

### 14.5.3 RF Reapter RFID

Item	Location	Default	New	Item	Location	Default	New
Repeater #01	1980 - 1987	0		Repeater #02	1990 - 1997	0	
Repeater #03	2000 - 2007	0		Repeater #04	2010 - 2017	0	
Repeater #05	2020 - 2027	0		Repeater #06	2030 - 2037	0	
Repeater #07	2040 - 2047	0		Repeater #08	2050 - 2057	0	

## 15 System Reporting Information

### 15.1 Arm/Disarm Reporting Options

Item	Location	Option	Default	New
Arm / Disarm Reporting Options	0403	0 = No Arm / Disarm Reports allowed 1 = Report to Receiver 1 2 = Report to Receiver 2 4 = Report to both Receiver 1 and Receiver 2 8 = Report to Receiver 2 only if Receiver 1 fails	1	

Location 403 is set by default to report only to Receiver 1. You can select whether Arm/Disarm Reports are sent to Receiver 1, Receiver 2, or both, Receiver 2 only when Receiver 1 fails, or no reporting.

### 15.2 Codepad Reporting Options

Item	Location	Option	Default	New
Codepad Reporting Options	0411	0 = No Codepad Alarm Reports allowed 1 = Report to Receiver 1 2 = Report to Receiver 2 4 = Report to both Receiver 1 and Receiver 2 8 = Report to Receiver 2 only if Receiver 1 fails	1	

Location 411 is set by default to report only to Receiver 1. You can select whether Codepad Alarm Reports are sent to Receiver 1, Receiver 2, or both, Receiver 2 only when Receiver 1 fails, or no reporting.

### 15.3 Access Denied

Item	Location	Option	Default	New
Code retry limit	0424	0 = Unlimited 1 – 15 = Error code attempts	6	

An Access Denied Report (Contact ID Event Code 461) is sent to the base station receiver when the number of incorrect code attempts equals the number programmed in Location 424. An Access Denied Alarm is audible, but you can program the alarm as silent by selecting Option 8 in Location 493 (refer to *System Options 2, page 135*).



#### Notice!

Restore Reports for this event are not transmitted.

#### Code Retries

The Code Retries feature restricts the number of times an invalid User Code can be entered in an attempt to operate the system. Location 424 sets the number of incorrect code attempts that causes an alarm. When the number of incorrect code attempts equals the number programmed in this location, the system performs these actions:

- Activates the sirens, internal screamers, and strobes connected to the control panel. Select Option 8 in Location 493 to change this alarm to silent.

- Shuts down all codepads connected to the control panel and locks them out for the time period programmed in Location 478 (refer to *Codepad Lockout Time*, page 132).
  - Sends an Access Denied Report (Contact ID Event Code 461) to the base station receiver.
- Each time the system is armed or disarmed, the Code Retries counter is reset. You can program the counter to a value from 1 to 15. If you want the number of incorrect code attempts to be unlimited, program a 0 in Location 424. In this case, the Access Denied Report is never generated and the system does not perform the three actions listed above. This function works when the system is armed or disarmed.

## 15.4 System Status Reporting Options

Item	Location	Option	Default	New
System Status Reporting Options	0427	0 = No report required 1 = Report to Receiver 1 2 = Report to Receiver 2 4 = Report to both Receiver 1 and Receiver 2 8 = Report to Receiver 2 only if Receiver 1 fails	1	

Location 427 is set by default to report only to Receiver 1. You can select whether System Status Reports are sent to Receiver 1, Receiver 2, or both, Receiver 2 only when Receiver 1 fails, or no reporting.

## 15.5 Test Reporting Time

Item	Location	Option	Default	New
Hour of day (tens digit)	0428		0	
Hour of day (units digit)	0429		0	
Minute of day (tens digit)	0430		0	
Minute of day (units digit)	0431		0	
Repeat interval in days	0434	0 = Disable 1 – 15 = 1 – 15 days	0	

A Test Report (Contact ID Event Code 601/602) is a specific signal sent to the base station receiver and is normally used to test the dialing and reporting functions of the control panel. When programming Test Report options, specify the hour and minute of the day the report is required, and how often to send the report. Test reports are reported on a daily basis from every day to every fifteen days. Program the Test Report Time as 34:00 to send reports every 60 minutes.

### Example

Set auto test report interval to the 37<sup>th</sup> minute of every hour, the time needs to be set as 34:37. Then the auto test report will be sent at 00:37, 01:37, 02:37, etc.

If you want to send Test Reports once every seven days at 11:35 PM (23:35), program Locations 428 to 431 as [2 3 3 5] and location 434 as [7].



### Notice!

If automatic Test Reports are not required, program the Hour/Minute/Repeat Interval in Locations 428 to 431 and 434 as 0.

## 15.6 Test Reporting Options

Item	Location	Option	Default	New
Test Reporting Options	0435	0 = No report required 1 = Report to Receiver 1 2 = Report to Receiver 2 4 = Report to both Receiver 1 and Receiver 2 8 = Report to Receiver 2 only if Receiver 1 fails	1	

Location 435 is set by default to report only to Receiver 1. You can select whether Test Reports are sent to Receiver 1, Receiver 2, or both, Receiver 2 only when Receiver 1 fails, or no reporting.

## 15.7 Reports

### 15.7.1 Zone Tamper Report

A Zone Tamper Report (Contact ID Event Code 144) is sent when Option 14 is programmed in Location 266 and the zone loop using split EOL resistors (3K3/6K8) with tamper (1K) becomes open circuit.

### 15.7.2 Walk Test Report

A Walk Test Report (Contact ID Event Code 607) is sent when either the Installer or Master Code holder activates Walk Test Mode.

### 15.7.3 Bypass Report

A zone is bypassed when it is manually isolated. A Zone Bypass Report (Contact ID Event Code 573) is sent at the end of Exit Time for any zone that was manually isolated. A 24-Hour Zone sends a Zone Bypass Report when the zone is selected to be isolated.

A Zone Bypass Restore Report is sent when the system is disarmed. All bypassed zones are automatically cleared when the system is disarmed.



#### Notice!

A 24-Hour Fire Zone that is manually bypassed reports as Contact ID Event Code 571.  
Other 24-Hour Zone that is manually bypassed reports as Contact ID Event Code 572.

### 15.7.4 Trouble Report

A zone is in trouble when it is unsealed at the end of Exit Time. A Sensor Trouble Report (Contact ID Event Code 380) is sent to indicate that one or more zones were automatically isolated by the system.

A Sensor Trouble Restore Report is sent for Burglary Zones when the zone is resealed or the next time the system is disarmed (whichever happens first). A 24-Hour Zone sends a restore signal only when it is resealed.

A 24-Hour Panic Zone Trouble is reported as Contact ID Event Code 375.

A 24-Hour Duress Zone Trouble is reported as Contact ID Event Code 376.

A 24-Hour Fire Zone Trouble is reported as Contact ID Event Code 373.

### 15.7.5 **Sensor Watch Report**

A Self Test Failure Report (Contact ID Event Code 391) is sent to the base station receiver when a zone was not activated during the Sensor Watch Time programmed in Locations 476 and 477.

To clear the fault, you must unseal and reseal the zone that registered the fault. Use the Sensor Watch Time in Locations 476 and 477 to set the number of days a zone can remain sealed without registering a fault. Refer to *Zone Options 1, page 97* to program the zone as Sensor Watch.

### 15.7.6 **Alarm Restore Code**

A Zone Restore Report is sent only to the receiving party to which the zone is allocated (for example, Receiver 1 or Receiver 2). Refer to *Zone Options 2, page 98* for Zone Restore Report.

### 15.7.7 **RF Receiver Trouble Report**

RF Signal Jamming (Contact ID Event Code 344, Point ID Code 821)

RF Receiver Tamper Switch (Contact ID Event Code 341, Point ID Code 821)

RF Receiver Missing (Contact ID Event Code 333, Point ID Code 821)

### 15.7.8 **RF Receiver Trouble Restore Report**

An RF Receiver Trouble Restore Report is sent to the base station receiver when the RF receiver no longer registers RF Signal Jamming, RF Receiver Tamper Switch, or RF Receiver Missing.

### 15.7.9 **RF Low Battery Report**

An RF Low Battery Report (Contact ID Event Code 384) is sent to the base station receiver when the battery voltage on a wireless zone falls below its corresponding low battery condition. An RF Low Battery Restore Report is sent on the first valid signal after the battery is replaced.

### 15.7.10 **Arm/Disarm Reports**

A Disarm Report (Contact ID Event Code 401) is sent to the base station receiver when the system is disarmed from AWAY Mode or STAY Mode. An Arm Report (Contact ID Event Code 401 for arming in AWAY Mode, Contact ID Event Code 441 for STAY Mode 1, Contact ID Event Code 456 for STAY Mode 2) is sent at the end of Exit Time when the system is armed.

The user number that armed or disarmed the system follows in the same transmission.

For a keyswitch zone, its zone number is reported as a user code number.

User Code for single button arming/disarming : 00.

User Code for arm tracking on Power Up : 994.

User Code for arming remotely by telephone : 995.

User Code for automatic arming/disarming : 997

User Code for arming and disarming using the A-Link Plus software / RSC : 998.

To enable Arm/Disarm Reports in STAY Mode: Select Option 2 in Location 178.

To enable Arm/Disarm Reports only after a previous alarm, select Option 1 in Location 178 (refer to *Communication Options 2, page 74*).

### 15.7.11 **Codepad Duress Report**

A Duress Report (Contact ID Event Code 121) is sent to the base station receiver when 9 is added to the end of any valid User Code used to disarm the system. This alarm is always silent. A Duress Alarm can be activated during Exit Time. In other words, if the system is

armed and then disarmed by adding 9 to the end of the User Code before Exit Time expires, a Codepad Duress Report is transmitted. Adding 9 to the end of a User Code when arming the system does not cause a Duress Alarm.

If you want a 3 to activate a Codepad Duress Alarm instead of 9, select Option 2 in Location 498 (refer to *Consumer Options 3*, page 138).

**Notice!**

Restore Reports are not sent for this event.

**15.7.12****Codepad Panic Report**

A Panic Alarm Report (Contact ID Event Code 120) is sent to the base station receiver when a user presses either [1] and [3] or [STAY] and [AWAY] at the same time. A Panic Alarm is audible, but you can program the alarm as silent by selecting Option 1 in Location 493 (refer to *System Options 2*, page 135).

**Notice!**

Restore Reports are not sent for this event.

**15.7.13****Codepad Fire Report**

A Fire Alarm Report (Contact ID Event Code 110) is sent to the base station receiver when a user presses [4] and [6] at the same time. A Fire Alarm is audible, but you can program the alarm as silent by selecting Option 2 in Location 493. A distinct fire sound is emitted through the horn speaker to indicate this type of alarm. The fire sound is different than the burglary sound.

Restore Reports are not sent for this event.

**15.7.14****Codepad Medical Report**

A Medical Report (Contact ID Event Code 100) is sent to the base station receiver when a user presses [7] and [9] at the same time. A Medical Alarm is audible, but you can program the alarm as silent by selecting Option 4 in Location 493.

Restore Reports are not sent for this event.

**15.7.15****AUX Power Supply Fail Report**

A System Trouble Report (Contact ID Event Code 312) is sent when either the codepad AUX power supply is blown or the AUX power supply malfunctions. The system reports the event approximately 10 sec after the failure.

**15.7.16****AUX Power Supply Fail Restore Report**

A System Trouble Restore Report (Contact ID Event Code 312) is sent when the AUX power supply is reset. The system reports the event approximately 10 sec after power supply is reset.

**15.7.17****AC Fail Report**

An AC Fail Report (Contact ID Event Code 301) is sent to the base station receiver when the AC MAINS supply is disconnected for 2 min. If you do not want an AC Fail Report to be sent until the AC MAINS supply is disconnected for 1 hour, select Option 1 in Location 494.



**15.7.18 AC Fail Restore Report**

An AC Fail Restore Report is sent when the AC MAINS supply is connected continuously for longer than 2 min.

**15.7.19 Low Battery Report**

A Battery Test Failure Report (Contact ID Event Code 302) is sent to the base station receiver when the system's battery voltage falls below 11 VDC or when a Dynamic Battery Test detects a low capacity battery.

The control panel continually monitors the battery voltage. A Dynamic Battery Test is done every time the system is armed and every 4 hours after the control panel is powered up.

**15.7.20 Low Battery Restore Report**

A Low Battery Restore Report is sent if the backup battery is restored the next time the system is armed, or when the next Dynamic Battery Test reports the battery test is OK when the system's battery voltage rises to 12 VDC.

## 16 Programmable Outputs

The control panel has four fully programmable outputs on the main printed circuit board and one programmable output that operates the codepad buzzer. The four outputs are set by default to operate as an alarm device, fire alarm verification, strobe, and internal screamer. The control panel supports additional 16 outputs via two output expanders. Programmable outputs require four parameters to operate correctly.

Parameter	Description
Event Type	The Event Type specifies when an output is activated. Enter the code for the Output Event Type into the two corresponding locations for the output.
Polarity	Polarity determines whether the output operates for the duration of the event, pulses for the duration, operates only once (one shot), or latches on.
Time Base/Time Multiplier	The Time Base and Time Multiplier parameters determine how long and how often the output operates.

Table 16.1: Output Parameters

### 16.1 Output Programming

Item	Location	Default	New	Item	Location	Default	New
<b>Output 1 (Default = Horn Speaker)</b>				<b>Output 2 (Default = Fire Alarm With Verification)</b>			
Event Code	0436	1		Event Code	0442	2	
Event Code	0437	14		Event Code	0443	7	
Polarity	0438	0		Polarity	0444	10	
Time Base	0439	0		Time Base	0445	2	
Time Base Multiplier	0440	0		Time Base Multiplier	0446	1	
Time Base Multiplier	0441	0		Time Base Multiplier	0447	5	
<b>Output 3 (Default = Strobe – Reset After 8 hrs.)</b>				<b>Relay Output (Default = Sirens Running)</b>			
Event Code	0448	2		Event Code	0454	1	
Event Code	0449	0		Event Code	0455	15	
Polarity	0450	6		Polarity	0456	1	
Time Base	0451	4		Time Base	0457	0	
Time Base Multiplier	0542	0		Time Base Multiplier	0458	0	
Time Base Multiplier	0453	8		Time Base Multiplier	0459	0	
<b>Codepad Buzzer (Default = Entry/Exit Warning and Day Alarm)</b>							
Event Code	0460	0					
Event Code	0461	13					

<b>Item</b>	<b>Location</b>	<b>Default</b>	<b>New</b>	<b>Item</b>	<b>Location</b>	<b>Default</b>	<b>New</b>
Polarity	0462	2					
Time Base	0463	1					
Time Base Multiplier	0464	0					
Time Base Multiplier	0465	1					

Item	Location	Default	New	Item	Location	Default	New
<b>B308 Output 1</b>				<b>B308 Output 2</b>			
Event Code	0646	0		Event Code	0652	0	
Event Code	0647	0		Event Code	0653	0	
Polarity	0648	0		Polarity	0654	0	
Time Base	0649	0		Time Base	0655	0	
Time Base Multiplier	0650	0		Time Base Multiplier	0656	0	
Time Base Multiplier	0651	0		Time Base Multiplier	0657	0	
<b>B308 Output 3</b>				<b>B308 Output 4</b>			
Event Code	0658	0		Event Code	0664	0	
Event Code	0659	0		Event Code	0665	0	
Polarity	0660	0		Polarity	0666	0	
Time Base	0661	0		Time Base	0667	0	
Time Base Multiplier	0662	0		Time Base Multiplier	0668	0	
Time Base Multiplier	0663	0		Time Base Multiplier	0669	0	
<b>B308 Output 5</b>				<b>B308 Output 6</b>			
Event Code	0670	0		Event Code	0676	0	
Event Code	0671	0		Event Code	0677	0	
Polarity	0672	0		Polarity	0678	0	
Time Base	0673	0		Time Base	0679	0	
Time Base Multiplier	0674	0		Time Base Multiplier	0680	0	
Time Base Multiplier	0675	0		Time Base Multiplier	0681	0	
<b>B308 Output 7</b>				<b>B308 Output 8</b>			
Event Code	0682	0		Event Code	0688	0	
Event Code	0683	0		Event Code	0689	0	
Polarity	0684	0		Polarity	0690	0	
Time Base	0685	0		Time Base	0691	0	
Time Base Multiplier	0686	0		Time Base Multiplier	0692	0	
Time Base Multiplier	0687	0		Time Base Multiplier	0693	0	

Item	Location	Default	New	Item	Location	Default	New
<b>B308 Output 9</b>				<b>B308 Output 10</b>			
Event Code	0694	0		Event Code	0700	0	
Event Code	0695	0		Event Code	0701	0	
Polarity	0696	0		Polarity	0702	0	
Time Base	0697	0		Time Base	0703	0	
Time Base Multiplier	0698	0		Time Base Multiplier	0704	0	
Time Base Multiplier	0699	0		Time Base Multiplier	0705	0	
<b>B308 Output 11</b>				<b>B308 Output 12</b>			
Event Code	0706	0		Event Code	0712	0	
Event Code	0707	0		Event Code	0713	0	
Polarity	0708	0		Polarity	0714	0	
Time Base	0709	0		Time Base	0715	0	
Time Base Multiplier	0710	0		Time Base Multiplier	0716	0	
Time Base Multiplier	0711	0		Time Base Multiplier	0717	0	
<b>B308 Output 13</b>				<b>B308 Output 14</b>			
Event Code	0718	0		Event Code	0724	0	
Event Code	0719	0		Event Code	0725	0	
Polarity	0720	0		Polarity	0726	0	
Time Base	0721	0		Time Base	0727	0	
Time Base Multiplier	0722	0		Time Base Multiplier	0728	0	
Time Base Multiplier	0723	0		Time Base Multiplier	0729	0	
<b>B308 Output 15</b>				<b>B308 Output 16</b>			
Event Code	0730	0		Event Code	0736	0	
Event Code	0731	0		Event Code	0737	0	
Polarity	0732	0		Polarity	0738	0	
Time Base	0733	0		Time Base	0739	0	
Time Base Multiplier	0734	0		Time Base Multiplier	0740	0	
Time Base Multiplier	0735	0		Time Base Multiplier	0741	0	

For output item options, refer to below *Output Item Options*.

Item	Option	
Event Code	0 0 = Reserved 0 1 = System armed 0 2 = System disarmed 0 3 = Armed in STAY mode 0 4 = Armed in AWAY mode 0 5 = Pre-arming alert 0 6 = Exit Warning (all zones sealed) and entry warning 0 7 = Exit Warning 0 8 = Exit Warning finished 0 9 = Kiss-off after end of Exit Time 0 10 = Reserved 0 11 = Entry warning 0 12 = Entry warning and day alarm resetting 0 13 = Exit warning and entry warning and day alarm resetting 0 14 = Day alarm resetting 0 15 = Day alarm latching	1 0 = Day alarm enabled 1 1 = Telephone line fail 1 2 = Kiss-off received 1 3 = AUX Power Supply fail 1 4 = AC fail 1 5 = Low battery 1 6 = Output 1 fail 1 7 = Sensor watch alarm 1 8 = Codepad medical alarm 1 9 = Codepad fire alarm 1 10 = Codepad panic alarm 1 11 = Codepad duress alarm 1 12 = Access denied (code retries) 1 13 = Reserved 1 14 = Horn speaker (output 1 only) 1 15 = Siren running
Event Code	2 0 = Strobe 2 1 = Silent alarm 2 2 = Alarm in STAY mode 2 3 = Alarm in AWAY mode 2 4 = System fault 2 5 = Fire alarm (resetting) 2 6 = Fire alarm (latching) 2 7 = Fire alarm (verification) 2 8 = Remote control 1 2 9 = Remote control 2 2 10 = Remote control 3 2 11 = Radio control output 1 2 12 = Radio control output 2 2 13 = Radio control output 1- not in AWAY Mode 2 14 = Radio control output 2- not in AWAY Mode 2 15 = Communications fail after 3 attempts	3 0 = Communications fail 3 1 = Report disabled 3 2 = Report active (on-line) 3 3 = Ring detect 3 4 = Codepad/Keyfob panic 3 5 = Mimic zone 1 3 6 = Mimic zone 2 3 7 = Mimic zone 3 3 8 = Mimic zone 4 3 9 = Mimic zone 5 3 10 = Mimic zone 6 3 11 = Mimic zone 7 3 12 = Mimic zone 8 3 13 = Reserved 3 14 = Reserved 3 15 = Reserved

Item	Option	
Event Code	4 0 = Reserved 4 1 = Reserved 4 2 = Reserved 4 3 = Reserved 4 4 = Reserved 4 5 = Chime 4 6 = Zone not sealed 4 7 = Zone not sealed after Exit Time 4 8 = Reserved 4 9 = AC MAINS cycle (60 Hz or 50 Hz) 4 10 = Area 1 – zone unsealed 4 11 = Area 2 – zone unsealed 4 12 = Reserved 4 13 = Reserved 4 14 = Reserved 4 15 = Reserved	5 0 = Reserved 5 1 = Reserved 5 2 = Area 1 in alarm 5 3 = Area 2 in alarm 5 4 = Reserved 5 5 = Reserved 5 6 = Area 1 armed 5 7 = Area 2 armed 5 8 = Reserved 5 9 = Reserved 5 10 = Area 1 disarmed 5 11 = Area 2 disarmed 5 12 = Reserved 5 13 = Reserved 5 14 = Any areas armed 5 15 = Any areas disarmed
Event Code	6 0 = Reserved 6 1 = Reserved 6 2 = Remote control 4 6 3 = Remote control 5 6 4 = Remote control 6 6 5 = Remote control 7 6 6 = Remote control 8 6 7 = Remote control 9 6 8 = Remote control 10 6 9 = Remote control 11	6 10 = Remote control 12 6 11 = Remote control 13 6 12 = Remote control 14 6 13 = Remote control 15 6 14 = Remote control 16 6 15 = Remote control 17 7 0 = Remote control 18 7 1 = Remote control 19 7 2 = Remote control 20
Polarity (Modes)	0 = Output not used 1 = Normally open, going low 2 = Normally open, pulsing low 3 = Normally open, one shot low 4 = Normally open, one shot low (reactivate) 5 = Normally open, one shot low (can reset) 6 = Normally open, one shot low (alarm) 7 = Normally open, latching low	8 = Normally low, going open 9 = Normally low, pulsing open 10 = Normally low, one shot open 11 = Normally low, one shot open (reactivate) 12 = Normally low, one shot open (can reset) 13 = Normally low, one shot open (alarm) 14 = Normally low, latching open
Time Base	0 = Reserved 1 = 200 ms 2 = 1 sec.	3 = 1 min. 4 = 1 hr.
Time Base Multiplier	Enter a value between 00 and 99.	

**Table 16.2: Output Item Options**

**\* One Shot Mode**

When you program the output polarity as one shot, the time base is multiplied by the time base multiplier. (For example, if the time base = 2 and the multiplier = 05, the output operates for 5 sec.)

**\*Pulsing Mode**

When you program the output polarity as pulsing, the time base becomes the ON time and the multiplier becomes the OFF time. The OFF time is the time base x the multiplier. (For example, if you want the output to pulse 1 sec. ON and 5 sec. OFF, you would program time base as 2 and the multiplier as 05.)

**Notice!**

When event code Remote control 1 – 20 is selected, polarity mode shall be programmed as time-independent option (including 1 = Normally open, going low, or 7, or 8, and 14).

## 16.2 Output Event Types

There are approximately 89 Output Event Types. Two numbers designate each Output Event Type. Program these numbers into the appropriate locations for the output.

**Notice!**

All reset times reference Polarity 1 and 8. Reset times vary depending on the selected polarity.

**0,1 System Armed**

This output operates when the system is armed. The output is reset when the system is disarmed. If the system is partitioned, this output operates when both areas are armed in AWAY Mode, STAY Mode 1 or STAY Mode 2.

**0,2 System Disarmed**

This output operates when the system is disarmed. The output is reset when the system is armed. If the system is partitioned, this output operates when both areas are disarmed.

**0,3 Armed in STAY Mode**

This output operates when the system is armed in STAY Mode 1 or STAY Mode 2. The output is reset when the system is disarmed. If the system is partitioned, this output operates when either area is armed in STAY Mode 1 or STAY Mode 2.

**0,4 Armed in AWAY Mode**

This output operates when the system is armed in AWAY Mode. The output is reset when the system is disarmed. If the system is partitioned, this output operates when either area is armed in AWAY Mode.

**0,5 Auto Arm Pre-Arming Alert Time**

This output operates during the time period before the control panel is automatically armed in AWAY Mode or STAY Mode 1. The output is reset when the control panel is automatically armed in AWAY Mode or STAY Mode 1. The Auto Arming Pre-Alert Time is programmed in Location 481.

**0,6 Exit Warning with All Zones Sealed or Entry Warning**

This output operates during Exit Time when the control panel is armed and all zones are sealed. The output is reset when Exit Time expires.

This output operates again during Entry Time and is reset when Entry Time expires or the system is disarmed.

This output also operates if a zone is activated when the system is armed in STAY Mode 1 or STAY Mode 2 and the Entry Guard Timer for STAY Mode is programmed in Locations 472 and 473.

**0,7 Exit Warning**



This output operates during Exit Time when the system is armed. The output is reset when Exit Time expires or the system is disarmed.

**0,8 Exit Warning Finished**

This output operates after Exit Time expires when the system is armed. The output is reset when the system is disarmed.

**0,9 Kiss-Off after Exit Time**

This output operates after the first successful transmission to the base station receiver when Exit Time expires. The output is reset when the system is disarmed.

**0,11 Entry Warning**

This output operates when during Entry Timer 1, Entry Timer 2, or Entry Guard Timer for STAY Mode. The output is reset when the Entry Time or Entry Guard Time expires or the system is disarmed. If Entry Time and Entry Guard time are present together, the output will follow the Entry Guard Time.

**0,12 Entry Warning + Day Alarm Resetting**

This output combines Entry Warning and Day Alarm Resetting so that either of these two events activates the output.

If the output is activated by Entry Timer 1, Entry Timer 2, or Entry Guard Timer for STAY Mode, the output is reset when the Entry Time or Entry Guard Time expires or the system is disarmed.

If a zone programmed for Day Alarm is activated when the system is disarmed and Day Alarm is turned on in the area to which this zone is allocated, the output is reset when the zone is resealed or Day Alarm is turned off in the area to which this zone is allocated or the system is armed. You can turn Day Alarm on and off by holding down [4] or selected from the menu on KP.

**0,13 Exit Warning + Entry Warning + Day Alarm Resetting**

This output operates when the system is armed, regardless of whether zones are sealed or unsealed, until Exit Time expires or the system is disarmed.

The output operates again during Entry Time and is reset when Entry Time expires or the system is disarmed. The output also operates during the Entry Guard Timer for STAY Mode time and is reset when the Entry Guard Time expires or the system is disarmed.

If a zone programmed for day alarm is activated when the system is disarmed or Day Alarm is turned off in the area to which this zone is allocated or the system is armed, the output is reset when the zone is resealed or Day Alarm is turned off in the area to which this zone is allocated or the system is armed. You can turn Day Alarm on and off by holding down [4] or selected from the menu on KP.

**0,14 Day Alarm Resetting**

This output operates when a zone programmed for Day Alarm is activated while the system is disarmed and Day Alarm is turned on in the area to which this zone is allocated. The output is reset when the Day Alarm zone is resealed or Day Alarm is turned off in the area to which this zone is allocated or the system is armed. You can turn Day Alarm on and off by holding down [4] or selected from the menu on KP.

**0,15 Day Alarm Latching**

This output operates when a zone programmed for Day Alarm is activated while the system is disarmed and Day Alarm is turned on in area to which the zone is allocated. The output is reset by pressing [AWAY]. You can turn Day Alarm on and off by holding down [4] or selected from the menu on KP.

If the control panel is partitioned, you can reset only this output on the area codepad to which the zone is allocated.

**1,0 Day Alarm Enabled**

This output operates when Day Alarm is enabled in any one used area. The output is reset when Day Alarm is turned off in all used areas.

You can turn Day Alarm on and off by holding down [4] or selected from the menu on KP.

Three beeps indicate that Day Alarm is turned on, two beeps indicate that Day Alarm is turned off.

#### **1,1 Telephone Line Fail**

This output operates when the built-in telephone line fault module detects that the telephone line is disconnected longer than 40 sec. The output is reset when the telephone line is restored continuously for 40 sec. This output does not operate unless Option 1 in Location 176 is selected or the function "Telephone Line Fault Indicator" (Menu 3-4-4) is enabled.

#### **1,2 Kiss-off Received**

This output operates after the control panel successfully transmitted to the receiving party, or else the output is reset.

#### **1,3 AUX Power Supply Fail**

This output operates when the 12V SDI2 BUS devices power supply or 12V zone or output AUX power supply fails. The output is reset when all fault AUX power supply above is reset..

#### **1,4 AC Fail**

This output operates when the AC MAINS fails. The output is reset when the AC MAINS is restored. This output operates regardless of whether Option 2 in Location 494 is selected or on TEXT codepad the Menu 341 "Ignore AC Fail" is enabled.

#### **1,5 Low Battery**

This output operates when a Dynamic Battery Test detects the battery failed or the battery voltage is below 11.0 VDC. The Dynamic Battery Test is performed every 4 hours after the system is powered up and every time the system is armed. This output is reset only after a Dynamic Battery Test reports that the backup battery voltage is normal.

#### **1,6 Output 1 Fail**

If the Enable Monitoring of warning device option (2) in Location 492 is selected or option "Warning Device Fault Monitor" (TEXT Codepad Menu 3-4-3) is enabled, this output operates when the horn speaker is disconnected. The output is reset when the horn speaker is reconnected.

#### **1,7 Sensor Watch Alarm**

This output operates when the Sensor Watch fault occurs. The output is reset when this fault clears.

#### **1,8 Codepad Medical Alarm**

This output operates when a user activates a Codepad Medical Alarm by pressing [7] and [9] at the same time on the remote codepad. This output is reset when a valid User Code is entered at the remote codepad.

#### **1,9 Codepad Fire Alarm**

This output operates when a user activates a Codepad Medical Alarm by pressing [4] and [6] at the same time on the remote codepad. This output is reset when a valid User Code is entered at the remote codepad.

#### **1,10 Codepad Panic Alarm**

This output operates when a user activates a Codepad Panic Alarm by pressing either [1] and [3] or [STAY] and [AWAY] at the same time on the remote codepad , or when a keyfob Panic Alarm is activated by pressing ARM button and DISARM button together on the learned keyfob. This output is reset when a valid User Code is entered at the remote codepad, or ARM or DISARM button on the keyfob is pressed to reset alarm.

#### **1,11 Codepad Duress Alarm**

This output operates when a user activates a Duress Alarm by adding a 9 to the end of the User Code used to disarm the system. This output is reset the next time the system is armed.

**1,12 Codepad PIN Error – Access Denied**

This output operates when the wrong code is entered more times than allowed. The number of incorrect attempts allowed is programmed in Location 424 or TEXT codepad option "Access Retry" (Menu 2-3). This output is reset when a valid User Code is entered after the codepad is unlocked.

**1,14 Horn Speaker (Output 1 Only)**

This output operates only on Output 1. Use this output for one or two 8 Ω horn speakers. To enable monitoring of the horn speaker, select Option 2 in Location 492.

**1,15 Sirens Running**

This output operates for the duration of the Siren Run Time programmed in Location 479. When the sirens are activated, this output is reset when the Siren Run Time expires. The relay output (Output 4) is set by default for this operation.

**2,0 Strobe Operating**

This output operates when an alarm occurs and is reset when a valid User Code is entered. The strobe output (Output 3) is set by default for strobe operation and is programmed to reset automatically after 8 hours.

**2,1 Silent Alarm**

This output operates when any zone programmed to be silent activates. The output is reset when the Siren Run Time expires, an audible alarm is activated, or a valid User Code is entered.

**2,2 Alarm When in STAY Mode**

This output operates when an audible alarm zone is activated when the system is armed in STAY Mode 1 or STAY Mode 2. The output is reset when the system is disarmed. Silent alarm will not trigger this event.

**2,3 Alarm When in AWAY Mode**

This output operates when an audible zone alarm is activated when the system is armed in AWAY Mode. The output is reset when the system is disarmed. Silent alarm will not trigger this event.

**2,4 Mimic System Fault**

This output operates when any system fault occurs. The output is reset when all system faults are restored.

**2,5 Fire Alarm Resetting**

This output operates when a 24-Hour Fire Zone or codepad fire alarm is activated. The output is reset when a valid User Code is entered or when Siren Run Time expires.

**2,6 Fire Alarm Latching**

This output operates when a 24-Hour Fire Zone or codepad fire alarm is activated and is reset when a valid user code is entered in system disarmed state or before the siren time expires in system armed state.

**2,7 Fire Alarm Verification**

This feature is used on some commercial fire control panels to reduce false alarms from smoke detectors. It is similar to zone pulse count used in some motion detectors. A fire zone is allotted a pulse count of 3 pulses over a period of 3 min.

If the smoke detector trips, the voltage to the smoke detector is disconnected for 15 sec and then reapplied. No alarm is registered.

If the unit activates again within 3 min of the first activation, no alarm is registered and the voltage to the smoke detector is again disconnected for 15 sec and then reapplied.

If a third activation is detected within 3 min of the first activation, (three pulses in 3 min) a fire alarm is registered. Power to the smoke detector is maintained to facilitate unit identification through the detector memory.

Connect this output to the negative side of any fire/smoke detector. To configure an output for this feature, use these settings.

EVENT TYPE – 2,7

POLARITY – 10

TIMEBASE – 2

MULTIPLIER – 15

The zone to which the fire or smoke detector is connected should be programmed as:

ZONE TYPE – 13

ZONE PULSE COUNT – 3

ZONE PULSE COUNT TIME – 15

### **2,8 Remote Control 1**

This output operates output when using the master code function or A-Link software or Smartphone App (RSC) to turn remote output 1 on. The output is reset when using the master code function or A-Link software or Smartphone App (RSC) to manually turn remote output 1 off or automatically turn remote output 1 off when the ON time expires if output polarity is from 3 to 6 or from 10 to 13.

### **2,9 Remote Control 2**

This output operates output when using the master code function or A-Link software or Smartphone App (RSC) to turn remote output 2 on. The output is reset when using the master code function or A-Link software or Smartphone App (RSC) to manually turn remote output 2 off or automatically turn remote output 2 off when the ON time expires if output polarity is from 3 to 6 or from 10 to 13.

### **2,10 Remote Control 3**

This output operates output when using the master code function or A-Link software or Smartphone App (RSC) to turn remote output 3 on. The output is reset when using the master code function or A-Link software or Smartphone App (RSC) to manually turn remote output 3 off or automatically turn remote output 3 off when the ON time expires if output polarity is from 3 to 6 or from 10 to 13.

### **2,11 Radio Control Output 1**

This output operates when the "1 Point" button (RADION) on the 4-button keyfob is toggled ON. The output is reset when this button is toggled OFF manually or automatically toggled off when the ON time expires if output polarity is from 3 to 6 or from 10 to 13.

### **2,12 Radio Control Output 2**

This output operates when the "2 Point" button (RADION) on the 4-button keyfob is toggled ON. The output is reset when this button is toggled OFF manually or toggled off automatically when the ON time expires if output polarity is from 3 to 6 or from 10 to 13.

If you select Option 8 in Location 492, this output does not operate and arms the system in STAY Mode 1 only.

### **2,13 Radio Control Output 1 – Not in AWAY Mode**

This output operates when the "1 Point" button (RADION) on the 4-button keyfob is toggled ON when the system is disarmed or armed in STAY Mode 1 or STAY Mode 2. The output is reset when this button is toggled OFF manually or automatically toggled off when the ON time expires if output polarity is from 3 to 6 or from 10 to 13. The output does not operate when the system is armed in AWAY Mode.

### **2,14 Radio Control Output 2 – Not in AWAY Mode**

This output operates when the "2 Point" button (RADION) on the 4-button keyfob is toggled ON when the system is disarmed or armed in STAY Mode 1 or STAY Mode 2. The output is reset when this button is toggled OFF manually or automatically toggled off when the ON time expires if output polarity is from 3 to 6 or from 10 to 13. The output does not operate when the system is armed in AWAY Mode.

If you select Option 8 in Location 492, this output does not operate and arms the system in STAY Mode 1 only.

### **2,15 Communications Failure after Three Unsuccessful Calls**

This output operates after the communicator makes three unsuccessful calls to any one used receiver. The output is reset when all messages are transmitted, or six unsuccessful or no calls to used receivers.

### **3,0 Communications Failure**

This output operates when either of the communication routes fault. The output is reset when both route faults clear.

### **3,1 Report Disabled**

This output operates when the communicator reporting functions allowed option (1) in Location 177 is not selected. The output is reset when Option 1 is selected.

### **3,2 Report Active**

This output operates when the transmission configuration of two paths for PSTN or CSVIP or email is not able to transmit data. The output is reset when at least one path's transmission configuration for PSTN or CSVIP or email is able to transmit data.

### **3,3 Ring Detect**

This output operates when an incoming call is detected by the control panel. The output is reset when the ringing stops or when the call is answered.

### **3,4 Codepad / Keyfob Panic (Multi-Break)**

This output operates when a Panic Alarm is initiated from the codepad or keyfob. The output operates for 200 ms if the polarity is programmed as 1 or 8. You can program the time base and multiplier to increase the period during which the output operates.

### **3,5 Mimic Zone 1**

### **3,6 Mimic Zone 2**

### **3,7 Mimic Zone 3**

### **3,8 Mimic Zone 4**

### **3,9 Mimic Zone 5**

### **3,10 Mimic Zone 6**

### **3,11 Mimic Zone 7**

### **3,12 Mimic Zone 8**

These output types mimic the zone inputs. The output operates when the zone is unsealed and is reset when the zone is sealed. They operate regardless of the selected zone type. Zone type can not be "Not Used". This feature operates when the system is armed or disarmed.

### **4,5 Global Chime**

This output operates when any Chime zones are activated. The output is reset when all Chime zones are resealed.

### **4,6 Zone Not Sealed**

This output operates when a Zone is unsealed. There are some conditions for the zone:

- 1> the zone type is valid, and is not chime, keyswitch
- 2> the zone is assigned to a valid partition
- 3> the zone is not bypassed

### **4,7 Zone Not Sealed after Exit Time**

This output operates if a Zone is unsealed and the exit time of the partition which the zone belongs to is end. There are some conditions for the zone:

- the zone type is valid, and is not chime, keyswitch
- the zone is assigned to a valid partition
- the zone is not bypassed

The output is reset when all zones are sealed or the system is disarmed.

#### **4,9 AC MAINS 60 Hz or 50 Hz**

This output is activated when the AC MAINS supply frequency is 60 Hz. The output is reset if the AC MAINS supply returns to 50 Hz.



#### **Notice!**

Output Event Types 4,10 through 6,1 are available only to partitioned control panels.

#### **4,10 Area 1 Has Unsealed Zone**

#### **4,11 Area 2 Has Unsealed Zone**

These two outputs operate when a zone in their corresponding area registers as unsealed either when the area is armed in AWAY Mode or STAY Mode, or the area is disarmed. There are some conditions for the zone:

- the zone type is valid, and is not chime, keyswitch
- the zone is assigned to a valid partition
- the zone is not bypassed

#### **Example**

Zone 1 is allocated to Area 1. If Zone 1 is unsealed, Output Event Type 4,10 operates. The output is reset when the zone is resealed.

#### **5,2 Area 1 in Alarm**

#### **5,3 Area 2 in Alarm**

These two outputs operate when a zone in their corresponding area registers an alarm. These outputs are reset when a valid User Code is entered or Siren Run Time expires.

#### **Example**

Zone 1 is allocated to Area 1. If Zone 1 registers an alarm, Output Event Type 5,2 operates. The output is reset when a valid User Code assigned to Area 1 is entered.

#### **5,6 Area 1 Is Armed**

#### **5,7 Area 2 Is Armed**

These two outputs operate when their corresponding area are armed in AWAY Mode or STAY Mode 1 or STAY Mode 2. The output is reset when the corresponding area is disarmed.

#### **Example**

If Area 1 is armed in AWAY Mode or STAY Mode 1 or STAY Mode 2, Output Event Type 5,6 operates. The output is reset when Area 1 is disarmed.

#### **5,10 Area 1 Is Disarmed**

#### **5,11 Area 2 Is Disarmed**

These two outputs operate when their corresponding area is disarmed. The output is reset when the corresponding area is armed.

#### **Example**

If Area 1 is disarmed, Output Event Type 5,10 operates. The output is reset when Area 1 is disarmed.

#### **5,14 Any Areas Armed**

This output operates when either Area 1 or Area 2 is armed in AWAY Mode or STAY Mode 1. The output is reset when both areas are disarmed.

#### **5,15 Any Areas Disarmed**

This output operates when either Area 1 or Area 2 is disarmed. The output is reset when both areas are armed in AWAY Mode or STAY Mode 1 or STAY Mode 2.

- 6,2 Remote Control 4**
- 6,3 Remote Control 5**
- 6,4 Remote Control 6**
- 6,5 Remote Control 7**
- 6,6 Remote Control 8**
- 6,7 Remote Control 9**
- 6,8 Remote Control 10**
- 6,9 Remote Control 11**
- 6,10 Remote Control 12**
- 6,11 Remote Control 13**
- 6,12 Remote Control 14**
- 6,13 Remote Control 15**
- 6,14 Remote Control 16**
- 6,15 Remote Control 17**
- 7,0 Remote Control 18**
- 7,1 Remote Control 19**
- 7,2 Remote Control 20**

These outputs operate output when using the master code function or A-Link software or Smartphone App (RSC) to turn remote output on. The output is reset when using the master code function or A-Link software or Smartphone App (RSC) to manually turn remote output off or automatically turn remote output 3 off when the ON time expires if output polarity is from 3 to 6 or from 10 to 13.

## 16.3 Output Polarity

There are fifteen different polarities. Each polarity is designated by a number that you program into the appropriate location for the output.

### **0 – Output Not Used**

If an output is not required, program the polarity as 0.

### **1 – Normally Open, Going Low**

This polarity is normally open circuit and switches to 0 V when the event occurs. The output switches back to open circuit when the event is restored. Time parameters do not apply to this polarity.

### **2 – Normally Open, Pulsing Low**

This polarity is normally open circuit and switches to pulsing 0 V when the event occurs. The output switches back to open circuit when the event is restored. Time parameters vary the On time (Time base) and Off time (Time Base\*Time Base Multiplier) of the pulse.

### **3 – Normally Open, One-Shot Low**

This one-shot polarity is normally open circuit and switches to 0 V when the event occurs. The output switches back to open circuit when the time parameter setting expires. This one-shot time setting always runs its full duration and cannot be manually reset.

### **4 – Normally Open, One-Shot Low with Reactivate**

This one-shot polarity is normally open circuit and switches to 0 V when the event occurs. Every time the event occurs, it restarts the one-shot timer. The output switches back to open circuit when the oneshot time expires. This one-shot time setting always runs its full duration. You cannot reset the time.

### **5 – Normally Open, One-Shot Low with Reset**

This one-shot polarity is normally open circuit and switches to 0 V when the event occurs. The output switches back to open circuit when the one-shot time expires or when the event returns to normal.

### **6 – Normally Open, One-Shot Low with Alarm**

This one-shot polarity is normally open circuit and switches to 0 V when the event occurs. The output switches back to open circuit when the one-shot time expires, the event returns to normal.

This polarity is ideally suited for the operation of strobe lights because you can program the lights to reset (up to 99 hours) and prevent them from burning out or bothering others due to prolonged operation.

#### **7 – Normally Open, Latching Low**

This polarity is normally open circuit and switches to 0 V when the event occurs. The output switches back to open circuit when a user holds down [7] on the remote codepad until two beeps sound. Time parameters do not apply to this polarity.

#### **8 – Normally Low, Going Open**

This polarity is normally 0 V and switches to open circuit when the event occurs. The output switches back to 0 V when the event is restored. Time parameters do not apply to this polarity.

#### **9 – Normally Low, Pulsing Open**

This polarity is normally 0 V and switches to pulsing open circuit when the event occurs. The output switches back to 0 V when the event is restored. Time parameters vary the Off time of the pulse. (Time base) and On time (Time Base\*Time Base Multiplier) of the pulse.

#### **10 – Normally Low, One-Shot Open**

This one-shot polarity is normally 0 V and switches to open circuit when the event occurs. The output switches back to 0 V when the time parameter expires. This one-shot time setting always runs its full duration and cannot be manually reset.

#### **11 – Normally Low, One-Shot Open with Reactivate**

This one-shot polarity is normally 0 V and switches to open circuit when the event occurs. Every time the event occurs, it restarts the one-shot timer. The output switches back to 0 V when the one-shot time expires. This one-shot time setting always runs its full duration. You cannot reset the time.

#### **12 – Normally Low, One-Shot Open with Reset**

This one-shot polarity is normally 0 V and switches to open circuit when the event occurs. The output switches back to 0 V when the one-shot time expires or when the event returns to normal.

#### **13 – Normally Low, One-Shot Open with Alarm**

This one-shot polarity is normally 0 V and switches to open circuit when the event occurs. Because the output switches back to 0 V when the one-shot time expires, the event returns to normal, or the system is disarmed, the one-shot timer can be shortened regardless of the time setting.

#### **14 – Normally Low, Latching Open**

This polarity is normally 0 V and switches to open circuit when the event occurs. The output switches back to 0 V when the user holds down [7] on the remote codepad until two beeps sound. Time parameters do not apply to this polarity.

## 16.4

### Output Timing

The timing of outputs is calculated by the time base and a multiplier. These two values play different roles depending on the selected polarity. When you program outputs to pulse, you can set both the On and Off times. You can program one-shot polarities to operate from 200 ms to 99 hours.



**Notice!**

The maximum value you can program in the two multiplier locations is 9,9.

The multiplier value is a two-digit decimal number from 00 to 99. For greater accuracy, use 60 sec for 1-min intervals and 60 min for 1-hour intervals.

## 16.5 Pulsing Polarities

When programming pulsing polarities, you must set both the On and Off times. The duration, or On time, for an output is determined by time base. In other words, there are only four possible On times.

The Off time is calculated by multiplying the On time by a decimal number between 00 and 99. If you want an output to operate for 200 ms every 5 sec, program the time settings as:

On Time: 1

Off Time: 2 5

On Time	Off Time	Increments	Tolerance
200 ms	200 ms to 19.8 sec	200 ms	±200 ms
1 sec	1 to 99 sec	1 sec	±1 sec
1 min	1 to 99 min	1 min	±1 min
1 hour	1 to 99 hr	1 hr	± 1 hr

**Table 16.3: Pulsing Time Settings**

## 16.6 One-Shot Polarities

The duration, or On time, of an output is determined by the product of the time base and the multiplier.

If you want an output to operate for 5 sec, program the time settings as:

Time Base: 2

Multiplier: 0 5

The On time is calculated by multiplying the time base setting (1 sec) by the multiplier value (05) (for example, 1 x 05 = 5 sec).

On Time	Increments	Tolerance
200 ms to 19.8 sec	200 ms	±200 ms
1 to 99 sec	1 sec	±1 sec
1 to 99 min	1 min	±1 min
1 to 99 hr	1 hr	± 1 hr

**Table 16.4: One-Shot Time Settings**

## 17 System Event Timers

This section covers the features that involve timing, such as Entry and Exit Times, Sensor Watch Time, and Siren Run Time.

### 17.1 Programming Entry/Exit Times

There are two programming locations for Entry Time 1, Entry Time 2, Exit Time for AWAY Mode, and Entry Guard Time for STAY Mode.

The first location of the timer allows you to set the timer in increments of 1 sec. The second location allows you to set the timer in increments of 16 sec. Add these two locations together for the total time.

#### Example

To set the Entry Time to 18 sec, program Location 466 as 2 (2 x 1 sec = 2 sec) and Location 467 as 1 (1 x 16 sec = 16 sec) for a total time of 18 sec (2 + 16 = 18).

### 17.2 Entry Time 1

Item	Location	Option	Default	New
Increments of 1 sec. (0 to 15 sec.)	0466		4	
Increments of 16 sec. (0 to 240 sec.)	0467		1	

You can program Entry Time 1 from 0 to 255 sec in increments of 1 sec. Entry Time 1 is the delay time used by the Delay-1 Zones.

#### See also

- *Zone Types, page 94*

### 17.3 Entry Time 2

Item	Location	Option	Default	New
Increments of 1 sec. (0 to 15 sec.)	0468		8	
Increments of 16 sec. (0 to 240 sec.)	0469		2	

You can program Entry Time 2 from 0 to 255 sec in increments of 1 sec. Entry Time 2 is the delay time used by Delay-2 Zones.

### 17.4 Exit Time

Item	Location	Option	Default	New
Increments of 1 sec. (0 to 15 sec.)	0470		12	
Increments of 16 sec. (0 to 240 sec.)	0471		3	

You can program the Exit Time from 0 to 255 sec in increments of 1 sec. When arming the system in AWAY Mode, the codepad beeps during Exit Time until the final 10 sec, when the codepad sounds one continuous beep to indicate the end of Exit Time is near.

The remote codepad always sounds one short beep at the end of Exit Time when arming in STAY Mode1 or STAY Mode 2.

## 17.5 Entry Guard Time for STAY Mode

Item	Location	Option	Default	New
Increments of 1 sec. (0 to 15 sec.)	0472		0	
Increments of 16sec. (0 to 240 sec.)	0473		0	

Entry Guard Time for STAY Mode is the delay time used for all zones except 24-Hour Zones when the system is armed in STAY Mode 1 or STAY Mode 2. All zones, including Delay Zones, use this time for the entry delay (for example, the Entry Guard Time overrides the delay time programmed for a Delay Zone). If the Entry Guard Time is programmed as 0, each zone acts according to its programmed zone type.

### See also

- *Zone Options 2, page 98*
- *Setting STAY Mode 2 Bypass Zones, page 45*

## 17.6 Delay Alarm Reporting Time

Item	Location	Option	Default	New
Increments of 1 sec. (0 to 15 sec.)	0474		0	
Increments of 16 sec. (0 to 240 sec.)	0475		0	

These locations program the time in sec that a delayed report waits dormant in the buffer before it is sent to the receiving party. If a User Code holder resets the alarm within this time frame, the control panel clears the communicator buffer and does not report the alarm to the receiving party.

### See also

- *Zone Options 1, page 97*

## 17.7 Sensor Watch Time

Item	Location	Option	Default	New
Increments of days (tens digit)	0476		0	
Increments of days (units digit)	0477		0	

The time set in these two locations determines the number of days (0 to 99) a zone can remain sealed before registering as a fault. This feature is active only when the system is disarmed. If a zone programmed for Sensor Watch is not unsealed and reset during this time, the FAULT indicator lights.

The Sensor Watch Time counter is active only when the control panel is disarmed. If the system is disarmed for 8 hours a day and the Sensor Watch Time is programmed for 1 day, a zone programmed for Sensor Watch registers a Sensor Watch Fault and sends the report (Contact ID Event Code 391) if it is not activated while disarmed within 3 days.

This feature is useful, for example, when someone places objects in the view of a motion detector, which prevents the detector from picking up movement.

## 17.8 Codepad Lockout Time

Item	Location	Option	Default	New
Codepad Lockout Time	0478	0 = No lockout 1 – 15 = Lockout time 10 – 150 sec. (Increments of 10 sec.)	0	

All codepads are locked out for the programmed time if an invalid code is entered more times than allowed by the code retry attempts programmed in Location 424. If the Codepad Lockout Time is programmed as 0, codepad lockout does not occur.

### See also

– *Access Denied, page 108*

## 17.9 Siren Run Time

Item	Location	Option	Default	New
Siren Run Time	0479	0 = No Siren time 1 – 15 = Siren time 1 – 15 min. (increments of 1 min.)	5	

The Siren Run Time determines how long the horn speaker/siren operates during an alarm. You can program the Siren Run Time from 0 to 15 min in 1-min intervals.

## 17.10 Siren Sound Rate

Item	Location	Option	Default	New
Siren Sound Rate	0480	0 = Slowest frequency 15 = Fastest frequency	7	

The Siren Sound Rate varies the frequency of the siren tone slowest (0) and to fastest (15). The Siren Sound Rate does not change the frequency of the fire alarm tone.

## 17.11 Auto Arming Pre-Alert Time

Item	Location	Option	Default	New
Auto Arming Pre-Alert Time	0481	0 = No alert time 1 – 15 = Alert time 5 – 75 min. (increments of 5 min.)	1	

This location sets the time period during which the control panel warns you it is automatically armed in AWAY Mode. The codepad beeps once every second until the Pre-Alert Timer expires: the system then automatically arms itself in AWAY Mode. If you want the system to automatically arm in STAY Mode 1, enable Option 4 in Location 496 (refer to *Consumer Options 1, page 137*).

After the control panel is automatically armed in AWAY Mode or STAY Mode 1, Exit Time starts. If a valid User Code is entered during the Pre-Alert Time, the Auto Arming Time programmed in Locations 482 to 485 is extended by 1 hour.

If you want a programmable output to operate during the Auto Arming Pre-Alert Time, use Output Event Type 0,5 Auto Arm Pre-Arming Alert Time.

### See also

– *Auto Arming Time, page 133*

– *Output Event Types, page 120*

## 17.12 Auto Arming Time

Item	Location	Option	Default	New
Hour of the day (tens digit)	0482		0	
Hour of the day (units digit)	0483		0	
Minute of the day (tens digit)	0484		0	
Minute of the day (units digit)	0485		0	

These locations specify the time of day the system automatically arms itself in AWAY Mode. Set this time in 24-hour format (for example, program 10:30 PM as 2230). If you want the system to arm in STAY Mode 1, select Option 4 in Location 496.

If forced arming is disabled for any zone, the automatic arming feature operates regardless of whether any zones are unsealed.

User Code 997 is reported when this feature is used. For partitioned control panels, both areas are automatically armed in AWAY Mode at the same time each day.

### See also

- *Consumer Options 1, page 137*
- *Zone Options 2, page 98*

## 17.13 Auto Disarming Time

Item	Location	Option	Default	New
Hour of the day (tens digit)	0486		0	
Hour of the day (units digit)	0487		0	
Minute of the day (tens digit)	0488		0	
Minute of the day (units digit)	0489		0	

These locations specify the time of day the system automatically disarms itself. Set this time in 24-hour format (for example, program 10:30 PM as 2230).

User Code 997 is reported when this feature is used. For partitioned control panels, both areas are automatically disarmed at the same time each day.

## 17.14 Kiss-Off Wait Time

Item	Location	Option	Default	New
Increments of 500 ms (500 ms to 8 sec.)	0490		3	

This location sets the time the control panel waits for acknowledgment before resending a report. This timer applies only to Contact ID and SIA Format.

## 17.15 Speaker Beep Volume

Item	Location	Option	Default	New
Speaker Beep Volume	0491	0 = No Beeps 15 = Loudest Beeps	13	

This location allows you to adjust the speaker volume for remote radio operation.

## 18 System and Consumer Options

The locations in this section have up to four options. You can select any combination of these options by programming a single value. Calculate this value by adding the option bit numbers together.

### 18.1 System Options 1

Item	Location	Option	Default	New
System Options 1	0492	1 = Bosch Security Systems smart lockout allowed 2 = Warning device fault monitor 4 = Strobe indication for radio arm/disarm 8 = Assign button 4 on keyfob to operate STAY Mode 1	1	

#### 1 – Smart Lockout Allowed

This feature allows the control panel to remove any zones that are programmed for lockout communication report from the lockout list when the sirens are running. This feature allows a monitoring station to receive zone alarm reports from previously locked out zones during siren time.

Refer to *Zone Options 1, page 97* for information on programming zones for lockout dialer and lockout siren.

Refer to *Swinger Shutdown Count for Report, page 102* to program the number of times the zone can report before being locked out.

#### 2 – Warning Device (Output1-3) Monitor

If this option is selected, the control panel detects when Output1-3 Event Type, programmed as a Warning Device (Horn speaker, Siren Running, Strobe), is disconnected from the terminals. The FAULT indicator lights when the Warning Device is disconnected and is extinguished when the Warning Device is reconnected.

If an output is required to operate when the Warning Device is disconnected, use Output Event Type 1,6 Output 1 Fail.

#### 4 – Strobe Indications for Radio Arm/Disarm

This option allows the strobe to indicate when the system is armed and disarmed when remotely operating the system using the RF Receiver.

Strobe Duration	System Status
3 sec	System disarmed
6 sec	System armed in AWAY Mode
6 sec	System armed in STAY Mode 1

**Table 18.1: Strobe Indications for Remote Operations**

#### 8 – Assign Button 4 on Keyfob To Operate STAY Mode 1

This option allows Button 4 on the RFKF-FB Keyfob to arm the system in STAY Mode 1.

## 18.2 System Options 2

Item	Location	Option	Default	New
System Options 2	0493	1 = Codepad panic to be silent 2 = Codepad fire to be silent 4 = Codepad medical to be silent 8 = Access denied (code retries) to be silent	0	

### 1 – Codepad Panic to Be Silent

If this option is selected, a Codepad Panic Alarm or Radio Remote Panic Alarm does not operate the horn speaker, the bell, or the strobe outputs. If this option is not selected, all three outputs operate after a Codepad Panic Alarm is activated when a user presses [1] and [3] or [STAY] and [AWAY] at the same time on the remote codepad. Selecting this option does not affect the operation of the communication report.

### 2 – Codepad Fire to Be Silent

If this option is selected, a Codepad Fire Alarm does not operate the horn speaker, the bell, or the strobe outputs. If this option is not selected, all three outputs operate after a Codepad Fire Alarm is activated when a user presses [4] and [6] at the same time on the remote codepad. Selecting this option does not affect the operation of the communication report.

### 4 – Codepad Medical to Be Silent

If this option is selected, a Codepad Medical Alarm does not operate the horn speaker, the bell, or the strobe outputs. If this option is not selected, all three outputs operate after a Codepad Medical Alarm is activated when a user presses [7] and [9] at the same time on the remote codepad. Selecting this option does not affect the operation of the communication report.

### 8 – Access Denied (Code Retries) to Be Silent

If this option is selected, a Codepad PIN Error Alarm does not operate the horn speaker, bell, or the strobe outputs. If this option is not selected, all three outputs operate after a Codepad PIN Error Alarm occurs. Selecting this option does not affect the operation of the communication report. If you want to disable the reporting of Access Denied reports, program Locations 424 as 0.

## 18.3 System Options 3

Item	Location	Option	Default	New
System Options 3	0494	1 = AC fail after 1 hr. (Disabled = after 2 min.) 2 = Ignore AC fail 4 = Pulse count handover allowed 8 = Handover delay to be sequential	8	

### 1 – AC Fail after 1 Hour

If this option is selected, the MAINS indicator flashes when the AC MAINS supply is disconnected. An AC Loss signal (Contact ID Event Code 301) is transmitted to the base station receiver after the AC MAINS supply is disconnected continuously for longer than 60 min.

If this option is not selected, the MAINS indicator flashes and an AC Loss signal (Contact ID Event Code 301) is transmitted to the base station receiver after the AC MAINS power is disconnected continuously for 2 min.

The MAINS indicator stops flashing when the AC MAINS supply is restored longer than 2 min. An AC Loss Restore Report is transmitted to the base station receiver after the AC MAINS supply is restored continuously for more than 2 min regardless of whether this option is selected.

#### 2 – Ignore AC Fail

If this option is selected, the MAINS indicator does not flash and the codepad does not beep every minute when the AC MAINS is disconnected from the control panel. If you want a programmable output to operate when the AC MAINS fails, use Output Event Type 1,4 AC Fail. An AC Loss report is transmitted to the base station receiver regardless of whether this option is selected.

#### 4 – Zone Pulse Count Handover

If this option is selected, any zone pulse count readings are handed over and accumulate to any zone that is activated during the same arming cycle. Zone pulse count handover only operates with zone pulse count time options 8 to 15. Refer to *Zone Pulse Count*, page 96 and *Zone Pulse Count Time*, page 97 for more information.



#### Notice!

24-Hour Zones cannot receive any handover pulses from other zones. 24-Hour Zones can hand over pulses to other zones.

#### 8 – Handover Delay to Be Sequential

If this option is selected, handover delay is sequential (that is, in zone numerical order from lowest to highest). If the sequence is broken before the Entry Time expires, an alarm occurs. If this option is not selected, handover delay follows the entry path if a Delay Zone is activated first. Refer to *Zone Types*, page 94 for more information about Handover Zones and Delay Zones.

#### Example:

Program zone 1 as Delay Zone and zone 2 and 3 as Handover Zone. When the Handover Delay to Be Sequential is selected and the zone 1 is activated:

If the zone 3 is activated first and the zone 2 is activated followed before the Entry Time of zone 1 expires, zone 3 alarms immediately, while zone 1 and zone 2 alarm after the Entry Time expired because zone 3 is higher than zone 2 in numerical order.

If the zone 2 is activated first and the zone 3 is activated followed before the Entry Time of zone 1 expires, zone 1 and zone 3 alarm after the Entry Time expired because the zones are activated in sequential.

## 18.4 System Options 4

Item	Location	Option	Default	New
System Options 4	0495	1 = Panel to power up disarmed (if power reset) 2 = Arm/disarm tracking on power up 4 = Reserved 8 = Reserved	2	

#### 1 – Panel To Power Up Disarmed

If this option is selected, the control panel powers up in the disarmed state when the battery and AC MAINS are reconnected after the system is powered down.

If this option is not selected, the system is always powered up armed in AWAY Mode.

#### 2 – Arm/Disarm Tracking on Power Up



If selected, the control panel keeps its current armed status in non-volatile memory. If the control panel is restarted due to a power failure, the control panel returns to being armed or disarmed as it was before the power failed.

#### Example

If the system is disarmed when the system is powered down, the system returns to the disarmed state when the system is powered back up.

## 18.5 Consumer Options 1

Item	Location	Option	Default	New
Consumer Options 1	0496	1 = Test reports only when armed 2 = Test report after siren reset 4 = Auto arm in STAY Mode 1 8 = STAY indicator to display day alarm status	0	

### 1 – Test Reports Only When Armed

If this option is selected, Test Reports (Contact ID Event Code 602) are only sent when the system is armed. It is no longer necessary to send a Test Report with an Arm/Disarm Report every day.

Most commercial premises are open during the working week, so a Test Report is not necessary because Arm/Disarm Reports are sent at the programmed time. If you want to manually send a Test Report, press and hold [9] button until two beeps sound.

Refer to *Test Reporting Time, page 109* to set the desired Test Report time. To set the first Test Report, refer to *Set the Number of Days until the First Test Report, page 42*.

### 2 – Test Report after Siren Reset

Select this option to force the control panel to send a Test Report (Contact ID Event Code 601) after the siren is reset. This can be used to indicate to the monitoring station that the control panel itself was not tampered with during the alarm period.

### 4 – Auto Arm in STAY Mode 1

Select this option if automatic arming in STAY Mode1 is preferred to automatic arming in AWAY Mode.

Program the time that the control panel automatically arms itself in Locations 482 to 485. Set the Auto Arming Pre-Alert Time in Location 481.

For partitioned control panels, both areas are automatically armed.

### 8 – STAY Indicator To Display Day Alarm Status

If this option is selected, the STAY indicator flashes once every 3 sec when Day Alarm is enabled.

Specify Day Alarm zones in Location 265.

You can turn Day Alarm on and off by holding down [4] for 2 sec. Three beeps indicate Day Alarm is turned on and two beeps indicate Day Alarm is turned off. Refer to *Day Alarm Operation, page 88* for more information.

## 18.6 Consumer Options 2

Item	Location	Option	Default	New
Consumer Options 2	0497	1 = Codepad displays extinguish after 60 sec. 2 = Single button arming allowed (AWAY/STAY Modes 1 and 2) 4 = Single button disarming allowed (STAY Modes 1 and 2) 8 = Alarm memory reset on disarm	2	

### 1 – Codepad Display Extinguish after 60 Sec

If this option is selected, all indicators on the codepad display are extinguished if a button is not pressed for 60 sec. The indicators lights again when there is an alarm (except a silent alarm), when a button is pressed on the codepad, when the AC MAINS fail beeps, or if the Entry Timer is activated.

### 2 – Single Button Arming Allowed

If this option is selected, the hold-down functions for arming in AWAY Mode, STAY Mode 1 and STAY Mode 2 are functional.

### 4 – Single Button Disarming Allowed

This option operates only when Option 2 in this location is also selected. This option allows hold-down functions for disarming from STAY Mode 1 and STAY Mode 2.

### 8 – Alarm Memory Reset on Disarm

If this option is selected, the alarm events memory clears from the codepad when the system is disarmed. If this option is not selected, the system must be armed and disarmed again to clear alarm memory from the codepad.

#### See also

- *Arm the System in AWAY Mode, page 53*
- *Arm the System in STAY Mode 1, page 53*
- *Arm the System in STAY Mode 2, page 53*

## 18.7 Consumer Options 3

Item	Location	Option	Default	New
Consumer Options 3	0498	1 = Codepad fault beeps allowed 2 = Use digit 3 for codepad duress alarm (instead of digit 9) 4 = Alarms activate sirens and strobe outputs in STAY Modes 1 and 2 8 = Zone tamper alarms to be silent	5	

### 1 – Codepad Fault Alarms Beep

If this option is selected, the FAULT indicator flashes and the codepad beeps once every minute until the user acknowledges a system fault. To acknowledge a new fault and stop the codepad from beeping once every minute, press [AWAY].

If this option is not selected, the codepad only the FAULT indicator flashes when a new fault occurs and the codepad does not beep once every minute.

### 2 – Digit 3 for Codepad Duress Instead of 9

If this option is selected, a user can add 3 (instead of a 9) to the code used to disarm the system to activate a Duress Alarm.

**4 – Alarms Activate Sirens and Strobe Outputs in STAY Modes 1 and 2**

Select this option if audible alarms are required when the system is armed in STAY Mode 1 or STAY Mode 2.

**8 – Zone Tamper Alarms To Be Silent**

This option allows Tamper Alarms, when Option 15 is programmed in Location 266 (refer to *EOL Resistor Value, page 89*), or Tamper Alarms on RF wireless devices to be silent when activated.

## 19 Partitioning

The Control Panel includes the partitioning feature, which can effectively transform your single control panel into two separate areas. Normally, arming and disarming the system turns the entire system on or off. When Control Panel is partitioned, you can arm or disarm an individual area without affecting the other area. Partitioning is extremely useful when you want to secure sheds, dual occupancy dwellings, accessory dwellings, shops, and offices.

### 19.1 Programming

Locations 500 and 501 apply only to a partitioned Control Panel.

These locations have up to four options. You can select any combination of these options by programming a single value. Calculate this value by adding the option bit numbers together.

#### 19.1.1 Partitioning Options 1

Item	Location	Option	Default	New
Partitioning Options 1	0500	1 = First to Disarm/Last to Arm reporting 2 = Reserved 4 = Reset sirens from any area allowed 8 = Reserved	0	

##### 1 – First To Disarm/Last To Arm Reporting

Select this option if only one Arm/Disarm Report is required for a partitioned system. Instead of sending individual Arm/Disarm reports for each area, an Arm Report is sent only after both areas are armed and a Disarm Report is sent as soon as one area is disarmed.

The reports are sent with the User Codes allocated to the specific area. You must allocate the user codes to the specific area and program user codes to have a priority level set with no arm/disarm reports.



##### Notice!

This option is applicable only when all User Codes have a priority level set with no arm/disarm reports. If User Codes have priority levels set to Arm/Disarm Reports, an Arm/Disarm report is always sent when any area is disarmed or armed, regardless of whether the area was first to disarm or last to arm.

##### 4 – Reset Sirens from Any Area Allowed

This option applies only to a partitioned control panel. If this option is selected, any valid User Code from Area 1 or Area 2 can reset the horn speaker, strobe, or bell outputs while in alarm. This option does not allow a User Code allocated to one area to disarm another area.

#### 19.1.2 Partitioning Options 2

Item	Location	Option	Default	New
Partitioning Options 2	0501	1 = Reserved 2 = User codes allowed to arm/disarm both areas at same time (Code [0][#]) 4 = Reserved 8 = Reserved	0	

## 2 – User Code Allowed to Arm/Disarm Both Areas at the Same Time

If this option is selected, any user allocated to both areas can arm or disarm both areas at the same time without entering the code at each area codepad.

If the user arms both areas at the same time and Option 1 is selected in Location 500, only an Arm Report for Area 2 is sent.

If the user disarms both areas at the same time and Option 1 is selected in Location 500, only a Disarm Report for Area 1 is sent.

### See also

- *Arm or Disarm both Areas at the Same Time, page 48*

## 19.2

### Partition Allocations

You can allocate up to 16 zones to each zone for the control panel. The 16 locations for each area are represented by the zone indicators on the ICON codepad. You can assign any zone to either area or both Area 1 and Area 2 to become a common zone.

Zones programmed as common zones report to the base station receiver on group zero (Area 1 – Group 1 and Area 2 – Group 2). Zones allocated to only one area report on the corresponding group number. Common zones, other than 24-Hour zone types, do not activate an alarm until both areas are armed in either AWAY Mode or STAY Mode 1.

Zone, user code, and codepad should be assigned to the correct area to operate. If a user code is assigned to an area only, the user code can only operate the assigned area on this area's codepad. For user code and authority level, refer to *User Code Priority, page 86*.

### Example:

#### Two methods to arm/disarm both areas at the same time:

- [User Code] + [0][# / \*]: this method requires to allocate the same user code to both areas as a common user code, then you can arm/disarm both areas at the same time with any area codepad. Refer to *Arm or Disarm both Areas at the Same Time, page 48* for more information.
- [User Code] + [# / \*]: this method requires to allocate the same user code to both areas as a common user code, and allocate the same codepad to both areas as a common codepad, then you can arm/disarm both areas at the same time with the common user code and common codepad.

#### Two methods to arm/disarm single area:

- [User Code] + [01] / [02] + [# / \*]: this method requires to allocate the same user code to both areas as a common user code, and you can arm/disarm any single area with any codepad.
- [User Code] + [# / \*]: this method requires to allocate the user code and codepad to either area, you can only arm/disarm the single area with corresponding user code and codepad.

### 19.2.1

#### Zone Area Assignments

Item	Location	Default	New	Item	Location	Default	New
Zone 1 Area	0502	1		Zone 2 Area	0503	1	
Zone 3 Area	0504	1		Zone 4 Area	0505	1	
Zone 5 Area	0506	1		Zone 6 Area	0507	1	
Zone 7 Area	0508	1		Zone 8 Area	0509	1	
Zone 9 Area	0510	1		Zone 10 Area	0511	1	

Item	Location	Default	New	Item	Location	Default	New
Zone 11 Area	0512	1		Zone 12 Area	0513	1	
Zone 13 Area	0514	1		Zone 14 Area	0515	1	
Zone 15 Area	0516	1		Zone 16 Area	0517	1	
<b>Option</b>							
0 = Zone area not assigned 1 = Zone assigned to Area 1				2 = Zone assigned to Area 2 3 = Zone assigned to both Area 1 and Area 2			

**Example**

Program Location 502 as 3, Location 503-509 as 1, Location 510-517 as 2, Zones 1-8 are allocated to Area 1 to appear as zones 1-8. Zones 1, 9-16 are allocated to Area 2 to appear as zones 1, 9-16. In each area's codepad, zone's original No is displayed. In this example, if Zone 16 is activated, in Area 2's ICON codepad, Zone 16 indicator lights. Programming the same zone into more than one area specifies that zone as a common zone.

Wireless zones and wired zones can share the same zone numbers. When the wireless zones are enabled, the wired zones allocated to the same numbers cannot respond anymore.

**See also**

- *Zone Programming, page 90*
- *RF Device RFID, page 106*

**19.2.2 Codepad assignment**

Item	Location	Default	New	Item	Location	Default	New
Codepad 1 Area	0518	1		Codepad 2 Area	0519	0	
Codepad 3 Area	0520	0		Codepad 4 Area	0521	0	
<b>Option</b>							
0 = Codepad area not assigned 1 = Codepad assigned to Area 1				2 = Codepad assigned to Area 2 3 = Codepad assigned to both Area 1 and Area 2			

Any codepad can be assigned to any area or both areas with a partitioned Control Panel.

**19.2.3 User code area assignments**

Item	Location	Default	New	Item	Location	Default	New
User Code 1	0534	1		User Code 2	0535	1	
User Code 3	0536	1		User Code 4	0537	1	
User Code 5	0538	1		User Code 6	0539	1	
User Code 7	0540	1		User Code 8	0541	1	
User Code 9	0542	1		User Code 10	0543	1	
User Code 11	0544	1		User Code 12	0545	1	
User Code 13	0546	1		User Code 14	0547	1	
User Code 15	0548	1		User Code 16	0549	1	

Item	Location	Default	New	Item	Location	Default	New
User Code 17	0550	1		User Code 18	0551	1	
User Code 19	0552	1		User Code 20	0553	1	
User Code 21	0554	1		User Code 22	0555	1	
User Code 23	0556	1		User Code 24	0557	1	
User Code 25	0558	1		User Code 26	0559	1	
User Code 27	0560	1		User Code 28	0561	1	
User Code 29	0562	1		User Code 30	0563	1	
User Code 31	0564	1		User Code 32	0565	1	
<b>Option</b>							
0 = User code not assigned 1 = User code assigned to Area 1				2 = User code assigned to Area 2 3 = User code assigned to both Area 1 and Area 2			

Locations 534 to 565 are used to assign each User Code to one or two area areas of a partitioned Control Panel. Enter a value from 0 to 3 into each of these locations to assign the User Code holder to the areas it must operate. You can allocate multiple User Codes to the same area.

User codes and RF user codes can share the same user code numbers. When the RF user codes is activated, the user codes allocated to the same numbers can also be used.

#### See also

- *User Codes, page 84*
- *RF Keyfob RFID, page 106*

---

## 20

### Text Information

Text items are for TEXT codepad only.

You can edit up to 18 alphanumeric for company name or other key text from location 2500 to 2535 as home message. And you can edit up to 12 alphanumeric for per zone name and user name from location 2536 to 3687.

**Notice!**

Instead of TEXT codepad, edit text via A-Link Plus is more convenient.

---





**Bosch Security Systems, Inc.**

130 Perinton Parkway

Fairport, NY 14450

USA

**[www.boschsecurity.com](http://www.boschsecurity.com)**

© Bosch Security Systems, Inc., 2015

**Bosch Sicherheitssysteme GmbH**

Robert-Bosch-Ring 5

85630 Grasbrunn

Germany