

FLEXIDOME IP panoramic 7000 MP

www.boschsecurity.com



BOSCH
Invented for life



- ▶ 12MP / 30 fps sensor for fine details with smooth motion
- ▶ Edge or client-side dewarping for easy integration
- ▶ Intelligent Video Analytics on full panoramic overview
- ▶ Discreet and aesthetic, low-profile design
- ▶ Easy twist-click installation

The FLEXIDOME IP panoramic 7000 MP is a discreet, aesthetic, low-profile camera for indoor use. The 12MP sensor operating at 30 fps provides full panoramic surveillance with complete area coverage, fine details and high speeds. The camera offers full situational awareness and simultaneous E-PTZ views in high resolution.

Versions

The 360° version of the camera, when mounted centrally on a ceiling, gives complete wall-to-wall coverage. The 180° version has a higher effective resolution and is ideal for wall mounting or for ceiling mounting in corridors.

Dewarping

The lens captures a circular image. Our dewarping software transforms this circular image into several different distortion-free rectangular views. To facilitate system integration, you can choose edge dewarping inside the camera or client-side dewarping on an external platform.

The freely available Video Security Client from Bosch provides advanced client-side dewarping features.

System overview

Advantages of panoramic surveillance

Panoramic surveillance offers full 180° or 360° coverage of the designated area. Because our panoramic cameras cover the full area, they provide complete situational awareness and are ideally suited to following movement in one continuous sweep.

180°



360°

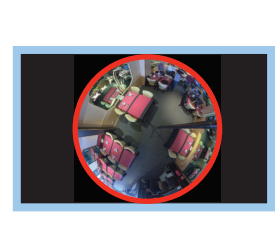

These panoramic cameras will considerably augment the functionality of any high-end surveillance system especially when coupled with Intelligent Video Analytics, for example, for people counting or complex rule-based alarm triggering.

Intelligent Video Analytics continuously monitors the full image circle so you still receive alarms even if you are zoomed-in on a particular region.

Functions

12MP sensor at 30 fps

The ultra high 12MP sensor resolution together with the exceptionally high frame rate of 30 fps makes this camera unique in the field of panoramic image capture. Motion is smoother and the E-PTZ feature provides more detailed images.

The effective resolution for the 180° version is 8MP and for the 360° version 7MP.

Choose your version of Video Analytics

The system reliably detects, tracks, and analyzes objects, and alerts you when predefined alarms are triggered. A smart set of alarm rules makes complex tasks easy and reduces false alarms to a minimum. Video analytics adds sense and structure to your video by adding metadata. Metadata is generated from the full image circle and also separately on the E-PTZ channel. This enables you to quickly retrieve the relevant images from hours of stored video. Metadata can also be used to deliver irrefutable forensic evidence or to optimize business processes based on people counting or crowd density information. The camera is available in two versions. You can choose Essential Video Analytics. Or choose Intelligent Video Analytics, with higher performance thanks to a built-in dedicated analytics chip.

Essential Video Analytics

The built-in video analysis reinforces the Intelligence-at-the-Edge concept and now delivers even more powerful features. Essential Video Analytics is ideal for use in controlled environments with limited detection ranges.

Intelligent Video Analytics

The camera uses the latest generation of the Bosch Intelligent Video Analytics (IVA) software. IVA combined with full panoramic vision produces an extremely powerful surveillance tool which enriches full situational awareness. With intelligent tracking, movement can be followed continuously throughout the full image circle. There is no need to hand off tracking from one camera to another, greatly simplifying movement analysis.

MOTION+

The MOTION+ video motion analysis system that is built into all camera versions is the perfect solution for applications where basic video content analysis features are required. MOTION+ shows motion metadata in an overlay display. By using MOTION+ data as input, smarter imaging algorithms bring improved image quality and more efficient bitrates. It also enables extended tamper detection capabilities.

Client-side dewarping

With client-side dewarping, the camera streams a single circular non-dewarped image at 30 fps. Dewarping is performed with our dewarping software

that is installed on the PC where multiple view modes are available or you can choose to use a third-party client-side dewarping software solution.

Edge dewarping

The edge dewarping in the camera provides three separate video channels simultaneously at 12.5 fps:

- Full image circle (Video 1 channel)
- Dewarped view mode (Video 2 channel)
- E-PTZ (Video 3 channel)

Different view modes can be selected for the video 2 channel. Your selection depends on the resolution you require and how you wish to view the dewarped image.

View modes

The following view modes can be selected at 12.5 fps with edge dewarping or 30 fps with our client side dewarping.

With the 180° lens version, you can select one of the following view modes for the second channel:

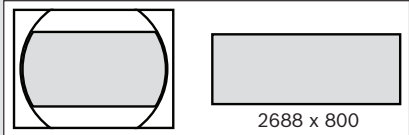
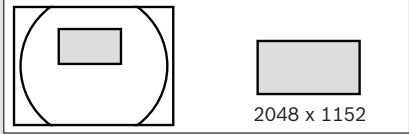
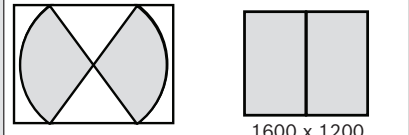
180° lens version	Full image cut-out and displayed image
Panoramic view	 2688 x 800
E-PTZ view	 2048 x 1152
Corridor view	 1600 x 1200

With the 360° lens version, select one of the following view modes for the second channel:

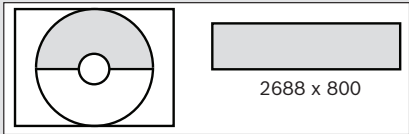
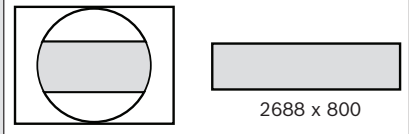
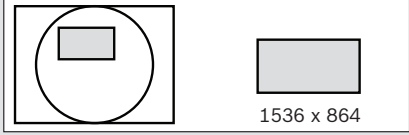
360° lens version	Full image cut-out and displayed image
Panoramic view (ceiling mount)	 2688 x 800
Panoramic view (wall mount)	 2688 x 800
E-PTZ view	 1536 x 864

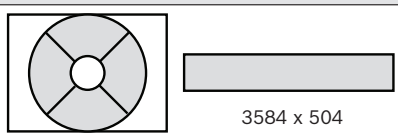
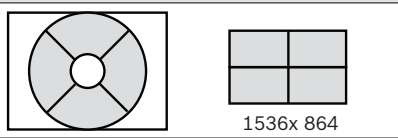
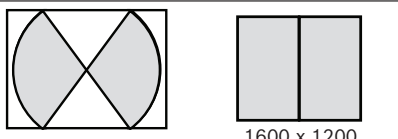
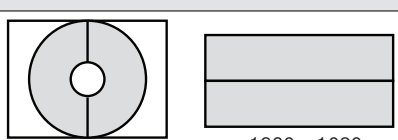
360° lens version	Full image cut-out and displayed image
Full panoramic view	 3584 x 504
Quad view	 1536x 864
Corridor view	 1600 x 1200
Double panoramic view	 1920 x 1080

DORI coverage

DORI (Detect, Observe, Recognize, Identify) is a standard system (EN-62676-4) for defining the ability of a camera to distinguish persons or objects within a covered area. The maximum distance at which a camera/lens combination can meet these criteria is shown below:

For high mounting applications, the center image DORI values are:

DORI	Object distance - 180°	Object distance - 360°
Detect	55 m (181 ft)	42 m (138 ft)
Observe	22 m (72 ft)	16.5 m (54 ft)
Recognize	10.5 m (35 ft)	8.5 m (28 ft)
Identify	5.5 m (18 ft)	4 m (13 ft)

When mounted at a height of 3 m (10 ft) the 360° version of the camera has the following coverage radius for the four levels:

DORI	DORI definition	Coverage radius
Detect	25 px/m (8 px/ft)	19 m (62 ft)
Observe	63 px/m (19 px/ft)	8.5 m (28 ft)
Recognize	125 px/m (38 px/ft)	4.5 m (15 ft)
Identify	250 px/m (76 px/ft)	2 m (7 ft)

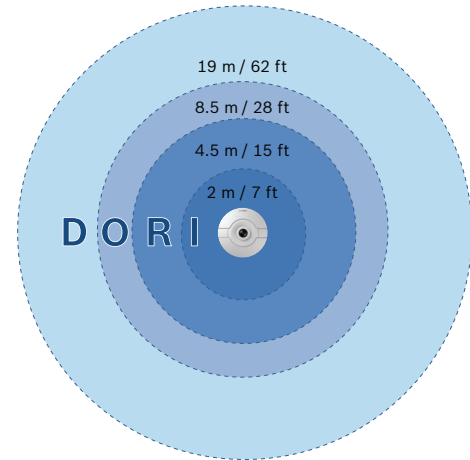

When mounted at a height of 3 m (10 ft) the 180° version of the camera has the following coverage radius for the four levels:

DORI	DORI definition	Coverage radius
Detect	25 px/m (8 px/ft)	28 m (92 ft)
Observe	63 px/m (19 px/ft)	12 m (40 ft)
Recognize	125 px/m (38 px/ft)	6.5 m (22 ft)
Identify	250 px/m (76 px/ft)	3.5 m (12 ft)

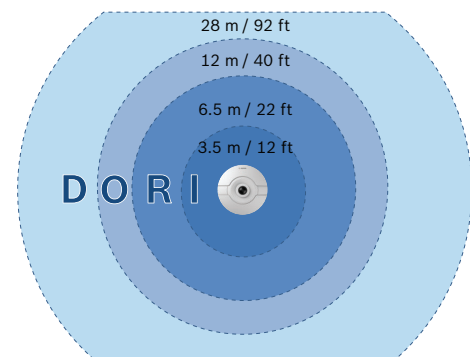

E-PTZ and regions of interest

The remote E-PTZ (Electronic Pan, Tilt and Zoom) controls allow you to select specific areas of the full image circle. These Regions of Interest (ROI) can be easily defined, allowing the most interesting part of a scene to be monitored separately. The high resolution ensures that details are not lost even when using the electronic zoom.

The E-PTZ feature of a panoramic camera has some advantages over normal PTZ cameras. There is no camera movement so the camera does not draw attention to itself or appear intrusive. Situational awareness is still retained even when zooming in on a particular object of interest. The smooth E-PTZ function helps navigation, and presets are available as they are with regular PTZ cameras.

Record exactly what you want

The camera provides the full resolution circular image for recording even if you are viewing only a portion of the scene. This means that you can always perform retrospective dewarping and analyses on the complete area covered and then zoom in on the region or object of interest.

With edge-dewarping you can also choose to only record the relevant parts of the scene which helps reduce bitrates significantly.

Intelligent Dynamic Noise Reduction

Quiet scenes with little or no movement require a lower bitrate. By intelligently distinguishing between noise and relevant information, Intelligent Dynamic Noise Reduction reduces bitrate by up to 50%. Because noise is reduced at the source during image capture, the lower bitrate does not compromise on video quality.

With the release of FW6.40 an extra level of intelligence is added with Intelligent Streaming. The camera provides the most usable image possible by cleverly optimizing the detail-to-bandwidth ratio. The smart encoder continuously scans the complete scene as well as regions of the scene and dynamically adjusts compression based on relevant information like movement. Together with Intelligent Dynamic Noise Reduction, which actively analyzes the contents of a scene and reduces noise artifacts accordingly, bitrates are reduced by up to 80%. Because noise is reduced at the source during image capture, the lower bitrate does not compromise image quality. This results in substantially lower storage costs and network strain and still retain a high image quality and smooth motion.

Area-based encoding

Area-based encoding is another feature which reduces bandwidth. Compression parameters for up to eight user-definable regions can be set. This allows uninteresting regions to be highly compressed, leaving more bandwidth for important parts of the scene. Area-based encoding is only available with client-side dewarping.

Bitrate optimized profile

The average typical optimized bandwidth in kbits/s for various image rates is shown in the table:

fps	12MP (full image circle)	Dewarped ROI (720p)
30	3100	-
25	2921	-
20	2640	-
12.5	2305	491
10	2192	432

fps	12MP (full image circle)	Dewarped ROI (720p)
5	1530	303
2	655	130

Measured dynamic range

The dynamic range of the camera is outstanding and is obvious in real-world performance comparisons – 92 dB wide dynamic range (plus an extra 16 dB when combined with Intelligent Auto Exposure).

The actual dynamic range of the camera is measured using Opto-Electronic Conversion Function (OECF) analysis with a standardized test chart based on ISO standards. This method provides more realistic and verifiable results in comparison with the theoretical approximations sometimes used.

Priority exposure control

To optimize image quality, eight zones for measuring the exposure can be drawn on the full image circle and assigned a priority level. These zones are given a higher or lower priority when the camera calculates the exposure level. This ensures that the important areas of the scene have the ideal exposure level.

Intelligent Auto Exposure

Fluctuations in backlight and front light can ruin your images. To achieve the perfect picture in every situation, Intelligent Auto Exposure automatically adjusts the exposure of the camera. It offers superb front light compensation and incredible backlight compensation by automatically adapting to changing light conditions.

Built-in microphone and audio alarm

The camera has a built-in microphone to allow operators to listen in on the monitored area. Audio detection can be used to generate an alarm if needed. If required by local laws, the microphone can be permanently blocked via a secure license key.

Unobtrusive design and easy installation

The low profile of the camera makes it exceedingly suitable for installations where aesthetics are important. Its unobtrusive nature allows it to fit in with architectural features without detracting from the surroundings. Museums, historic buildings or impeccably designed interiors will all benefit from the discreet design.

The camera is easily mounted to any surface using a twist-click mechanism via the supplied mounting ring. The high quality IR corrected lens is factory focused and is not restricted by a bubble, so installation is simplified and sharpness is assured.

The LED indicators, reset button and SD card slot are easily accessed via two hinges at the front of the camera. A complete set of indoor mounting accessories, such as a surface mount box or a pendant pipe mount, are available.

Power for the camera is supplied via a Power-over-Ethernet compliant network cable connection. With this configuration, only a single cable connection is required to view, power, and control the camera.

Scene modes

The camera has a very intuitive user interface that allows fast and easy configuration. Nine configurable modes are provided with the best settings for a variety of applications. Different scene modes can be selected for day or night situations.

Storage management

Recording management can be controlled by the Bosch Video Recording Manager (Video Recording Manager) or the camera can use iSCSI targets directly without any recording software.

Edge recording

Insert a memory card into the card slot to store up to 2 TB of local alarm recording. Pre-alarm recording in RAM reduces recording bandwidth on the network, and extends the effective life of the memory card.

Cloud-based services

The camera supports time-based or alarm-based JPEG posting to four different accounts. These accounts can address FTP servers or cloud-based storage facilities (for example, Dropbox). Video clips or JPEG images can also be exported to these accounts.

Alarms can be set up to trigger an e-mail or SMS notification so you are always aware of abnormal events.

Access security

Password protection with three levels and 802.1x authentication is supported. To secure Web browser access, use HTTPS with a SSL certificate stored in the camera.

Complete viewing software

There are many ways to access the camera's features: using a web browser, with the Bosch Video Management System, with the free-of-charge Bosch Video Client or Video Security Client, with the video security mobile app, or via third-party software. The Video Security Client has extensive dewarping capabilities and can be used for client-side dewarping as well as for viewing the available modes.

System integration

The camera conforms to the ONVIF Profile S specifications. Compliance with these standards guarantees interoperability between network video products regardless of manufacturer.

Third-party integrators can easily access the internal feature set of the camera for integration into large projects. Visit the Bosch Integration Partner Program (IPP) website (ipp.boschsecurity.com) for more information.

Certifications and approvals

Standards	Type
Emission	EN 50121-4:2016; EN 55032: 2013, Class A; CFR 47 FCC part 15:2012-10-1, Class B;
Immunity	EN 50121-4:2016; EN 50130-4:2011*
Safety	EN 60950-1:2006, +A11:2009, +A1:2010, +A12:2011, AC:2011; UL 60950-1, 2nd edition:2011; CAN/CSA-C 22.2 No. 60950-1-07, 2nd edition
Environmental tests	EN 50130-4:2011, Class II (Indoor in general, fixed equipment), Alarm systems - Part 5: Environmental test methods
Environmental	EN 50581 (2012)
Marks	CE, cULus, WEEE, PADS, RCM and China RoHS
Image quality	UL 2802

* All systems where this camera is used must comply with this standard as well.

Region	Regulatory compliance/quality marks	
Europe	CE	ce_Certificate
USA	UL	
	FCC	

Installation/configuration notes

Camera dimensions

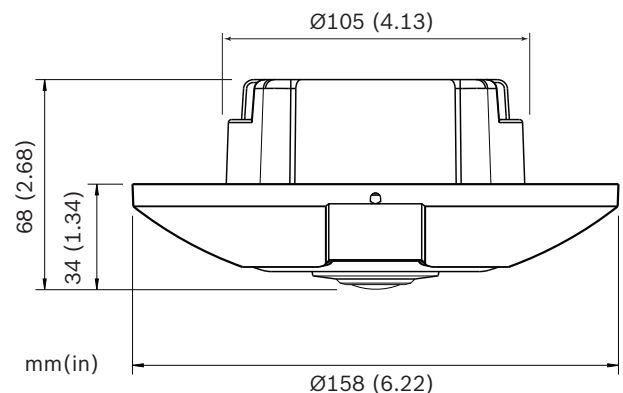

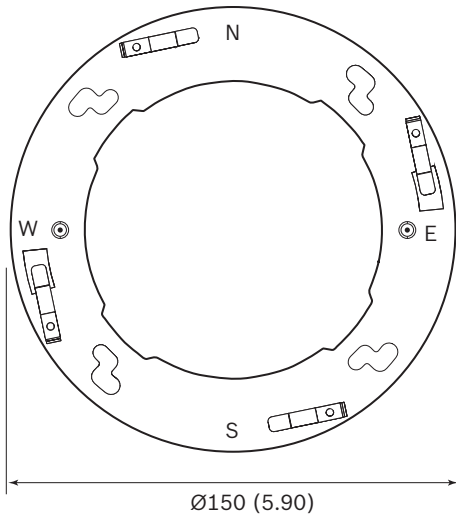

Surface mount box dimensions

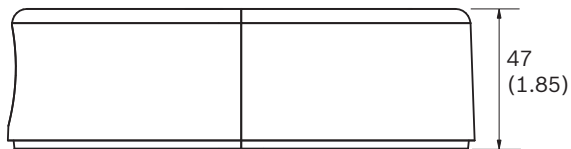
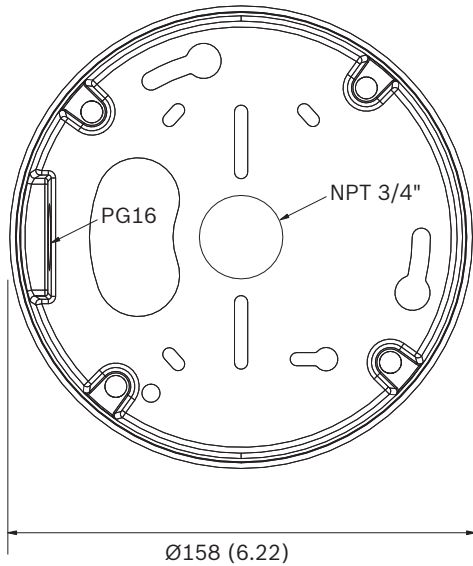

Technical specifications

Power

Power Supply	Power-over-Ethernet 48 VDC nominal
Power Consumption	140 mA 200 mA (Intelligent Video Analytics version)
PoE	IEEE 802.3af (802.3at Type 1)

Sensor

Type	1/2.3-inch CMOS
Total sensor pixels	12MP
Used pixels (180° version)	3648 x 2160 (8MP)
Used pixels (360° version)	2640 x 2640 (7MP)

Video performance – Sensitivity – 360° lens

(3100K, reflectivity 89%, F2.8, 30IRE)

Color	0.55 lx
Mono	0.18 lx

Video performance – Sensitivity – 180° lens

(3100K, reflectivity 89%, F2.8, 30IRE)

Color	0.46 lx
Mono	0.15 lx

Video performance – Dynamic range

Dynamic range	92 dB WDR (+16 dB IAE)
---------------	------------------------

Video streaming

Video compression	H.264 (MP); M- JPEG
Streaming	Multiple configurable streams in H.264 and M- JPEG, configurable frame rate and bandwidth. Multiple channels with edge dewarping. Regions of Interest (ROI)
Overall IP Delay	Min. 120 ms, Max. 340 ms
Encoding interval	1 to 25 [30] ips
Encoder regions	Eight independent areas for setting encoder quality to optimize bitrate.

Video resolution (H x V) – 180° version

Video 1 channel	Image circle	3640 x 2160
Video 2 channel	Panoramic	2688 x 800
	E-PTZ	2048 x 1152
Video 3 channel	Corridor	1600 x 1200
	E-PTZ	1280 x 720

Video resolution (H x V) – 360° version

Video 1 channel	Full image circle	2640 x 2640
Video 2 channel	Full panoramic	3584 x 504
	E-PTZ	1536 x 864
	Quad	1536 x 864

Video resolution (H x V) – 360° version		
	Panoramic	2688 x 800
	Double panoramic	1920 x 1080
	Corridor	1600 x 1200
Video 3 channel	E-PTZ	1280 x 720

Video functions	
Day/Night	Color, Monochrome, Auto (adjustable switchover points)
Adjustable picture settings	Contrast, Saturation, Brightness
White Balance	2500 to 10000K, 4 automatic modes (Basic, Standard, Sodium vapor, Dominant color), Manual mode and Hold mode
Shutter	Automatic Electronic Shutter (AES) Fixed (1/30 [1/25] to 1/15000) selectable Default shutter
Sharpness	Sharpness enhancement level selectable
Backlight compensation	Off / On / Intelligent Auto Exposure (BLC)
Contrast enhancement	On/off
Noise reduction	Intelligent Dynamic Noise Reduction Intelligent streaming
Intelligent defog	Intelligent Defog automatically adjusts parameters for best picture in foggy or misty scenes (switchable)
Exposure region	Multiple selectable regions
Privacy Masking	Eight independent areas, fully programmable
Video Content Analysis	MOTION+, Essential Video Analytics and Intelligent Video Analytics
Pre-positions	Six independent sectors
Display stamping	Individual names and stamps for all video channels
Other functions	Pixel counter, Video watermarking, Location

Optical	
Lens (180° version)	2.1 mm fixed-focus lens (IR corrected), F2.8
Lens (360° version)	1.6 mm fixed-focus lens (IR corrected), F2.8
Lens mount	Board mounted
Iris control	Fixed iris
Field of view (180° version)	180° (H) x 93° (V)

Optical	
Field of view (360° version)	180° (H) x 180° (V)
Minimum object distance	0.1 m
Day/Night	Switched mechanical IR filter

Audio	
Audio input	Integrated microphone (can be permanently disabled)

Audio streaming	
Standard	G.711, 8 kHz sampling rate L16, 16 kHz sampling rate AAC-LC, 48 kbps at 16 kHz sampling rate AAC-LC, 80 kbps at 16 kHz sampling rate
Signal-to-Noise Ratio	>50 dB
Audio Streaming	Full-duplex / half duplex

Local storage	
Internal RAM	10 s pre-alarm recording
Memory card slot	Supports up to 32 GB SDHC / 2 TB SDXC card. (An SD card of Class 6 or higher is recommended for HD recording)
Recording	Continuous recording, ring recording, alarm/events/schedule recording

Software	
Unit discovery	IP Helper
Unit configuration	Via web browser or Configuration Manager
Firmware update	Remotely programmable
Software viewing	Web browser; Video Security Client; Video Security App; Bosch Video Management System; Bosch Video Client; or third party software
Latest firmware and software	http://downloadstore.boschsecurity.com/

Network	
Protocols	IPv4, IPv6, UDP, TCP, HTTP, HTTPS, RTP/RTCP, IGMP V2/V3, ICMP, ICMPv6, RTSP, FTP, ARP, DHCP, APIPA (Auto-IP, link local address), NTP (SNTP), SNMP (V1, V3, MIB-II), 802.1x, DNS, DNSv6, DDNS (DynDNS.org, selfHOST.de, no-ip.com), SMTP, iSCSI, UPnP (SSDP), DiffServ (QoS), LLDP, SOAP, Dropbox™, CHAP, digest authentication
Encryption	TLS 1.2, SSL, DES, 3DES

Network	
Ethernet	10/100 Base-T, auto-sensing, half/full duplex
Connectivity	Auto-MDIX
Interoperability	ONVIF Profile S; GB/T 28181
Mechanical	
Dimensions	158 x 33 mm (6.22 x 1.30 in)
Weight	526 g (1.16 lb)
Environmental	
Operating Temperature	-20°C to +40°C (-4°F to 104°F)
Storage Temperature	-20°C to +60°C (-4°F to 140°F)
Operating humidity	20% to 93% RH
Storage humidity	up to 98% RH

Ordering information

NIN-70122-F1 Fixed dome 12MP 180°

High-performance 12MP sensor low-profile camera for intelligent panoramic surveillance

180° lens

Essential Video Analytics

Order number **NIN-70122-F1**

EWE-FD7PAN-IW 12mths wrty ext FD IP panoramic 7000

12 months warranty extension

Order number **EWE-FD7PAN-IW**

NIN-70122-F0 Fixed dome 12MP 360°

High-performance 12MP sensor low-profile camera for intelligent panoramic surveillance

360° lens

Essential Video Analytics

Order number **NIN-70122-F0**

EWE-FD7PAN-IW 12mths wrty ext FD IP panoramic 7000

12 months warranty extension

Order number **EWE-FD7PAN-IW**

NIN-70122-F1A Fixed dome 12MP 180° IVA

High-performance 12MP sensor low-profile camera for intelligent panoramic surveillance

Intelligent Video Analytics

180° lens

Order number **NIN-70122-F1A**

EWE-FD7PAN-IW 12mths wrty ext FD IP panoramic 7000

12 months warranty extension

Order number **EWE-FD7PAN-IW**

NIN-70122-F0A Fixed dome 12MP 360° IVA

High-performance 12MP sensor low-profile camera for intelligent panoramic surveillance

Intelligent Video Analytics

360° lens

Order number **NIN-70122-F0A**

EWE-FD7PAN-IW 12mths wrty ext FD IP panoramic 7000

12 months warranty extension

Order number **EWE-FD7PAN-IW**

NIN-70122-F1S Fixed dome 12MP 180° surface-mount

High-performance 12MP sensor low-profile camera for intelligent panoramic surveillance

180° lens

Surface mount box

Essential Video Analytics

Order number **NIN-70122-F1S**

NIN-70122-F0S Fixed dome 12MP 360° surface-mount

High-performance 12MP sensor low-profile camera for intelligent panoramic surveillance

360° lens

Surface mount box

Essential Video Analytics

Order number **NIN-70122-F0S**

NIN-70122-F1AS Fixed dome 12MP 180° IVA surface-mount

High-performance 12MP sensor low-profile camera for intelligent panoramic surveillance

Intelligent Video Analytics

180° lens

Surface mount box

Order number **NIN-70122-F1AS**

NIN-70122-F0AS Fixed dome 12MP 360° IVA surface-mount

High-performance 12MP sensor low-profile camera for intelligent panoramic surveillance

Intelligent Video Analytics

360° lens

Surface mount box

Order number **NIN-70122-F0AS**

Accessories

VDA-70112-SMB Surface mount box

Surface mount box for FLEXIDOME IP panoramic 7000 MP cameras

Order number **VDA-70112-SMB**

VDA-PLEN-DOME In-ceiling housing for plenum, FLEX-IDOME

In-ceiling housing for plenums kit for several series of Bosch dome cameras

Order number **VDA-PLEN-DOME**

NPD-5001-POE Power over ethernet , 15.4W, 1-port

Power-over-Ethernet midspan injector for use with PoE enabled cameras; 15.4 W, 1-port

Weight: 200 g (0.44 lb)

Order number **NPD-5001-POE**

NPD-5004-POE Power over ethernet, 15.4W, 4-port

Power-over-Ethernet midspan injectors for use with PoE enabled cameras; 15.4 W, 4-ports

Weight: 620 g (1.4 lb)

Order number **NPD-5004-POE**

NDA-U-PMT Pendant pipe mount, 12" (31cm)

Universal pipe mount for dome cameras, 31 cm, white

Order number **NDA-U-PMT**

NDA-U-PMTE Pendant pipe extension, 20" (50cm)

Extension for universal pipe mount, 50 cm, white

Order number **NDA-U-PMTE**

NDA-U-PSMB Pendant wall/ceiling mount SMB

Surface mount box (SMB) for wall mount or pipe mount.

Order number **NDA-U-PSMB**

NDA-7010-PIP Pendant interface plate for NIN-70112

Pendant interface plate for FLEXIDOME IP panoramic 7000.

Order number **NDA-7010-PIP**

Services

EWE-FD7PAN-IW 12mths wrty ext FD IP panoramic 7000

12 months warranty extension

Order number **EWE-FD7PAN-IW**

Represented by:

Europe, Middle East, Africa:
Bosch Security Systems B.V.
P.O. Box 80002
5600 JB Eindhoven, The Netherlands
Phone: + 31 40 2577 284
emea.securitysystems@bosch.com
emea.boschsecurity.com

Germany:
Bosch Sicherheitssysteme GmbH
Robert-Bosch-Ring 5
85630 Grasbrunn
Germany
www.boschsecurity.com

North America:
Bosch Security Systems, Inc.
130 Perinton Parkway
Fairport, New York, 14450, USA
Phone: +1 800 289 0096
Fax: +1 585 223 9180
onlinehelp@us.bosch.com
www.boschsecurity.us

Asia-Pacific:
Robert Bosch (SEA) Pte Ltd, Security Systems
11 Bishan Street 21
Singapore 573943
Phone: +65 6571 2808
Fax: +65 6571 2699
apr.securitysystems@bosch.com
www.boschsecurity.asia